

Saga

Scale Mercury series
Postal scale
Readme

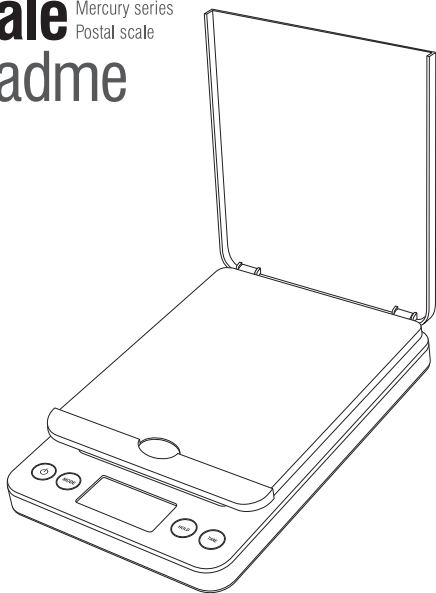

INDEX

1.Specifications	2
2.Before Starting	3
a.Battery and AC adaptor installation	3
b.Screen and buttons	4
3.Start Weighing	5
a.Scale setup	5
b.Take readings	7
c.Tare	7
d.Auto-hold and oversized package	8
e. Flip holder	9
4.Errors and Troubleshooting	10
5.Maintenance	12

1. Specifications

- Capacity:** 46lb/20kg; 66lb/30kg; 86lb/40kg
- Resolution:** 0.1oz, 0.01lb or 5g
- Load cell:** 1 x heavy duty bridge style strain gauge
- Measure modes:** Pound & ounce; Pound; ounce; Kilogram; Gram
- Other features:** Tare deduction, Auto hold switch, Auto turn off, Flip holder, Screen backlight(optional)

Your SAGA Mercury includes the following components:

(1) SAGA Mercury postal scale x1

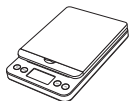

(2) AA batteries x2



(3) User manual x1



(4) AC Adapter x1 (Optional)

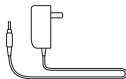

2. Before Starting

a. Battery and AC adaptor installation

This device works on either 2 X AA size batteries or the AC adaptor(110-240V AC to 5V DC).

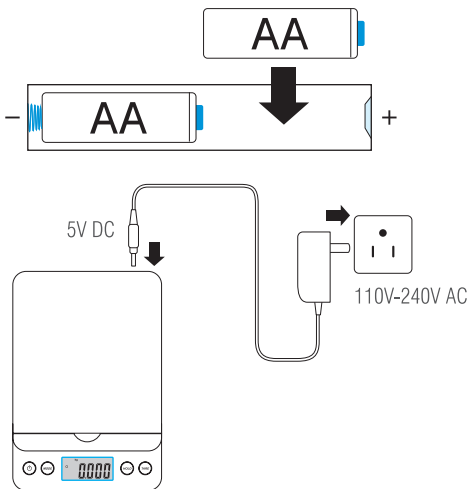

b. Screen and buttons

Screen layout:

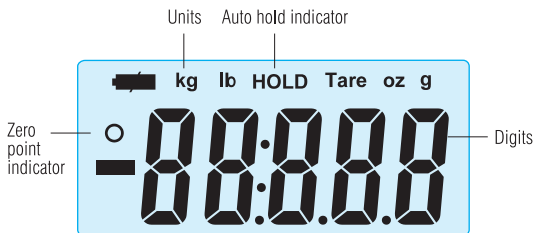

On:

Turn on/off the scale



Tare:

Zero out/ Tare deduction



Mode:

Switch between units



Auto hold:

Turn on/off auto hold function



3. Start Weighing

a. Scale setup

Place the device on a flat and solid surface.

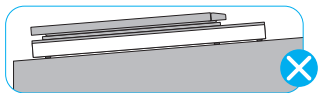
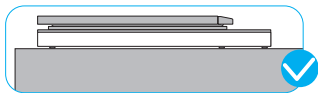

Press "On" button once to turn on the scale.



After the greeting message “SAGA” displayed on the screen.



Press “mode” button to see measuring units.

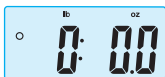

Pound and ounce



Kilogram



Pound

Now you can place the item/s on the scale.

Please place the item at the center of the platform.

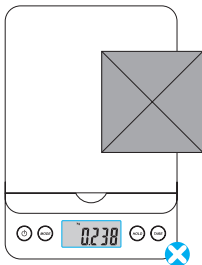
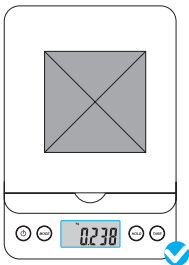

b. Take readings

Do not disturb your scale, when numbers on the scale stop changing you can take the reading. Here are some examples:

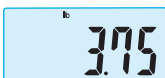
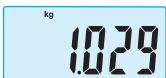
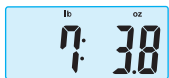
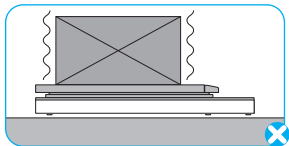

c. Tare

By pressing the "Tare" button you can force the device to zero out.

Tips

*Get the net weight of item in a container:

Place an empty container on the scale, then press "Tare", then you can drop item/s into the container and measure the net weight of item/s.

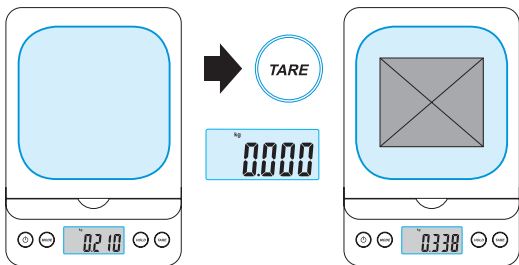

d. Auto hold and oversized package

If the item blocked the LCD, auto hold mode can help you to take a reading.

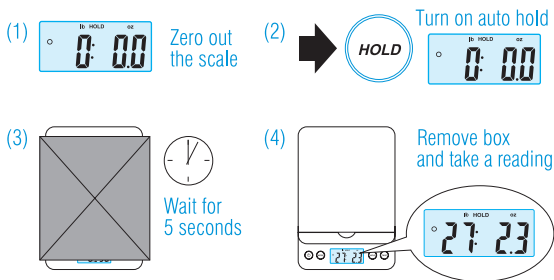

Press hold to turn on the auto hold mode.

Put the package on the Scale wait for 5 seconds, and then remove the item. The reading will be locked on the screen.

Press hold button again to unlock, and quit the auto hold mode.



Tips:

If you need to adjust the weight, please turn off the auto hold mode.

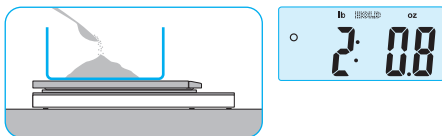

e. Flip holder

The Flip holder can be used to hold large envelope, round or irregular shaped items.

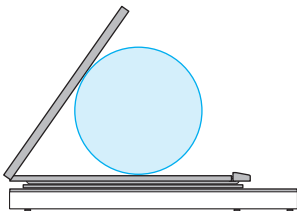

4. Errors and Trouble shooting

Not turning on:

Please check the battery installation and the AC adapter connection. When using battery, please make sure the AC adapter is NOT connected to the scale.

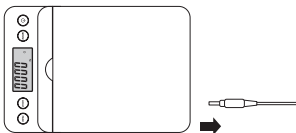

Not accurate:

Tips may help:

1. Please be sure the device is level. And make sure it is on a hard solid surface.
2. Disconnect the AC connection, use fresh batteries.
3. Keep the device away from strong magnet, and extreme hot, cold, humidity environment.

4.Keep the device away from Cell Phone and the other wireless devices.

5.Place item/s at the center of the scale.

Error codes:

1.Err: over loaded



Remove the load from the scale immediately.

2.Lo: battery low

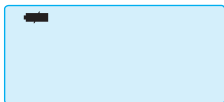

Replace the battery or connect to the AC adapter.

5. Maintenance

1. You can clean your scale with damp cloth, but try to keep your scale dry and **DO NOT** wash your scale.

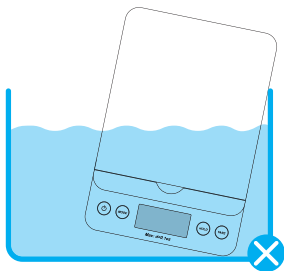

2. Recommended operating temperature:

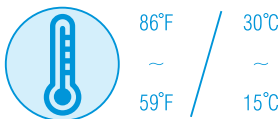

3. Do not over load

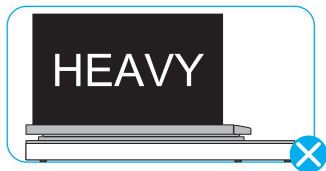

4. When the scale is not in use, please empty the tray, do not put the scale upset down.

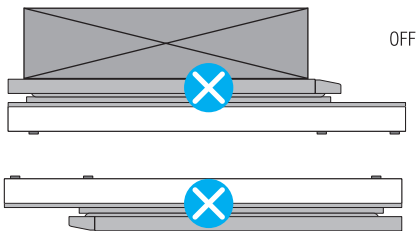

5. If the scale won't be used for a long time, please remove the batteries.

