



ORDER FORM

Print pages 1-25 to exclude pictures.

Q700M

with SEDEO[®] PRO[™]
and JAY[®] Syncra[™] Seating

EIPW25

Customer		Ship To	
Account #		Name	
Date		Address	
PO#		City	
Buyer		State	Zip
Mark For		Phone	

Client Measurements

a) Top of head to seat		in
b) Top of shoulder to seat		in
c) Underarm to seat		in
d) Elbow to seat		in
e) Top of leg to seat		in
f) Shoulder width		in
g) Chest width		in
i) Hip width		in
j) Actual sitting depth		in
m) Foot length		in
n) Knee to foot		in
o) Seat width		in

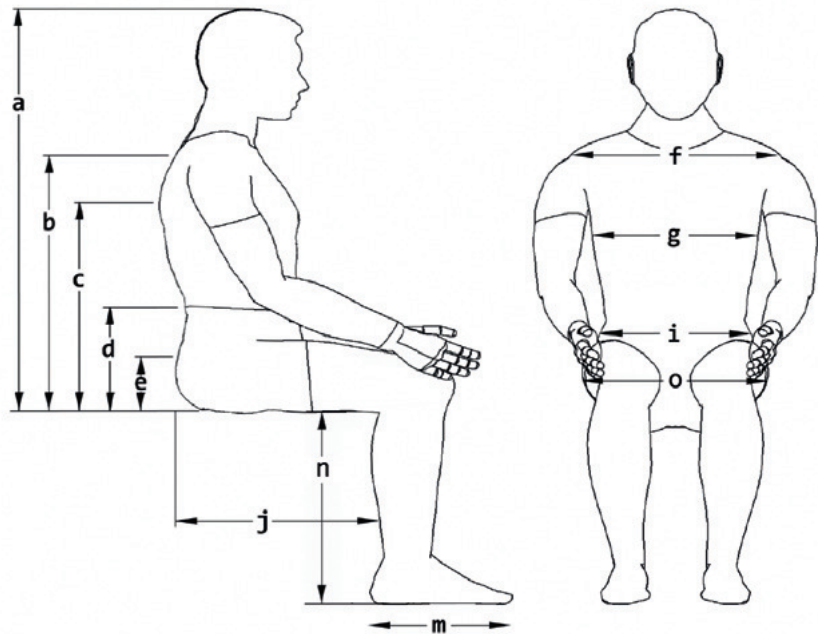

Notes

Chair Specifications

HCPC	K0848 / K0850 / K0856 / K0858 / K0861 K0862 / K0868 / K0877 / K0884
Typical Weight w/out Batteries	330 lbs.
Typical Weight with Batteries	410 lbs.
Power Seating	50° of CG Tilt and Power Recline with 4" mechanical shear reduction / 12" seat elevator
Seat Type	SEDEO® PRO™ / JAY® Syncra™
Seat Size Range	Width 16" to 22" Depth 14" to 22"
Seat-to-Floor Height Range	16.5" to 19"

Mid-Wheel Drive Base Specifications

Drive Wheel Position	Mid-wheel drive
User Weight Capacity	250 lbs. / 300 lbs. / 350 lbs. HD
Base Size	Width 24.5", Length 36.5"
Minimum Turning Radius	19.8" (excludes footplates)
Drive Control	R-net PM 120A / R-net PM 90A
Driving Range	Up to 18 miles (w/ Group 24 Batteries)
Drive Motors	4-pole 6 mph, 5 mph HD, 8 mph
Drive Wheels	14" w/flat-free inserts (black) 14" w/pneumatic inserts (black)
Casters	6" front / 6" rear (black)
Charger	10A Dual Mode (Compact)
Battery Size	Group 24 / Group 34
Color	8 shroud colors and 6 color accents
Maximum Ground Clearance	3"

BASE			
OPTION	HCPC	DESCRIPTION	RETAIL
Group 3 Standard Duty Mid Wheel Drive Base <i>End Item Number EIPW25 (PRO™ Seat)</i>			\$
<input type="checkbox"/> 250PC197	K0848	Quickie Q700 M NPC No Power Option for SEDEO® PRO™ Seat Included in Base Pricing : Q700 M Base, R-net 90amp Electronics for No Power Seat Functions, SpiderTrac 2.0 Six-Wheel Independent Suspension, 14" Drive Wheels with Dual Density Inserts, 6" Flat Free Casters, ISO Occupied Tie-Down Brackets and 10amp Charger. Max Speed = 6mph, Weight Capacity = 300lbs., STFH = 16.5".	\$7,850.00
<input type="checkbox"/> 250PC198	K0856	Quickie Q700 M SPC Single Power Option for SEDEO® PRO™ Seat Included in Base Pricing : Q700 M Base, R-net 90amp Electronics for No Power Seat Functions, SpiderTrac 2.0 Six-Wheel Independent Suspension, 14" Drive Wheels with Dual Density Inserts, 6" Flat Free Casters, ISO Occupied Tie-Down Brackets and 10amp Charger. Max Speed = 6mph, Weight Capacity = 300lbs., STFH = 16.5".	\$7,850.00
<input type="checkbox"/> 250PC203	K0861	Quickie Q700 M MPC Tilt/Recline for SEDEO® PRO™ Seat Included in Base Pricing: Q700 M Base, R-net 90amp Electronics for No Power Seat Functions, SpiderTrac 2.0 Six-Wheel Independent Suspension, 14" Drive Wheels with Dual Density Inserts, 6" Flat Free Casters, ISO Occupied Tie-Down Brackets and 10amp Charger. Max Speed = 6mph, Weight Capacity = 300lbs., STFH = 16.5".	\$7,850.00
Group 3 Heavy Duty Mid Wheel Drive Base <i>End Item Number EIPW25 (PRO™ Seat)</i>			\$
<input type="checkbox"/> 250PC199	K0850	Quickie Q700 M NPC HD No Power Option for SEDEO® PRO™ Seat Included in Base Pricing : Q700 M Base, R-net 90amp Electronics for No Power Seat Functions, SpiderTrac 2.0 Six-Wheel Independent Suspension, 14" Drive Wheels with Dual Density Inserts, 6" Flat Free Casters, ISO Occupied Tie-Down Brackets and 10amp Charger. Max Speed = 5mph, Weight Capacity = 350lbs., STFH = 16.5".	\$10,100.00
<input type="checkbox"/> 250PC200	K0858	Quickie Q700 M SPC HD Single Power Option for SEDEO® PRO™ Seat Included in Base Pricing : Q700 M Base, R-net 90amp Electronics for No Power Seat Functions, SpiderTrac 2.0 Six-Wheel Independent Suspension, 14" Drive Wheels with Dual Density Inserts, 6" Flat Free Casters, ISO Occupied Tie-Down Brackets and 10amp Charger. Max Speed = 5mph, Weight Capacity = 350lbs., STFH = 16.5".	\$10,100.00
<input type="checkbox"/> 250PC204	K0862	Quickie Q700 M MPC HD Tilt/Recline for SEDEO® PRO™ Seat Included in Base Pricing: Q700 M Base, R-net 90amp Electronics for No Power Seat Functions, SpiderTrac 2.0 Six-Wheel Independent Suspension, 14" Drive Wheels with Dual Density Inserts, 6" Flat Free Casters, ISO Occupied Tie-Down Brackets and 10amp Charger. Max Speed = 5mph, Weight Capacity = 350lbs., STFH = 16.5".	\$10,100.00
Group 4 Standard Duty Mid Wheel Drive Base <i>End Item Number EIPW25 (PRO™ Seat)</i>			\$
<input type="checkbox"/> 250PC201	K0868	Quickie Q700 M NPD No Power Option for SEDEO® PRO™ Seat Included in Base Pricing : Q700 M Base, R-net 120amp Electronics for No Power Seat Functions, SpiderTrac 2.0 Six-Wheel Independent Suspension, 14" Drive Wheels with Dual Density Inserts, 6" Flat Free Casters, ISO Occupied Tie-Down Brackets and 10amp Charger. Max Speed = 8mph, Weight Capacity = 300lbs., STFH = 16.5".	\$12,500.00
<input type="checkbox"/> 250PC202	K0877	Quickie Q700 M SPD Single Power Option for SEDEO® PRO™ Seat Included in Base Pricing : Q700 M Base, R-net 120amp Electronics for No Power Seat Functions, SpiderTrac 2.0 Six-Wheel Independent Suspension, 14" Drive Wheels with Dual Density Inserts, 6" Flat Free Casters, ISO Occupied Tie-Down Brackets and 10amp Charger. Max Speed = 8mph, Weight Capacity = 300lbs., STFH = 16.5".	\$12,500.00
<input type="checkbox"/> 250PC205	K0884	Quickie Q700 M MPD Tilt/Recline for SEDEO® PRO™ Seat Included in Base Pricing: Q700 M Base, R-net 120amp Electronics for No Power Seat Functions, SpiderTrac 2.0 Six-Wheel Independent Suspension, 14" Drive Wheels with Dual Density Inserts, 6" Flat Free Casters, ISO Occupied Tie-Down Brackets and 10amp Charger. Max Speed = 8mph, Weight Capacity = 300lbs., STFH = 16.5".	\$12,500.00

BASE				
OPTION	HCPC	DESCRIPTION		RETAIL
User Weight				\$
<input type="checkbox"/>	250WG22	–	Up to 250 lbs.	NC
<input type="checkbox"/>	250WG03	–	251 to 300 lbs.	NC
<input type="checkbox"/>	250WG15	–	301 to 350 lbs.	NC
Motor Package				\$
<input type="checkbox"/>	250PF98	–	4-pole 8 kph / 5 mph (Standard for Group 3 HD K0850, K0858, K0862)	NC
<input type="checkbox"/>	250PF99	–	4-pole 10 kph / 6 mph (Standard for Group 3 K0848, K0856, K0861)	NC
<input type="checkbox"/>	250PF100	–	4-pole 12.5 kph / 8 mph (Standard for Group 4 K0868, K0877, K0884)	NC
<input type="checkbox"/>	250PF101	–	4-pole 12.5 kph / 8 mph (Upgrade for Group 3 K0848, K0856, K0861)	\$1,150.00
Tracking				\$
<input type="checkbox"/>	250MI01	K0108	SureTrac® Module & Motor Encoders (Improves drive tracking)	\$1,395.00
Drive Wheels  P. 27				\$
<input type="checkbox"/>	250DW58	–	Drive Wheel, 14", Dual Density, Knobby, Black	NC
<input type="checkbox"/>	250DW68	–	Drive Wheel, 14", Pneumatic, V-type, Black	\$250.00
Caster Wheels  P. 27				\$
<input type="checkbox"/>	250CW55	–	Caster Wheels 6", Solid, Black	NC
Wheel Locks				\$
<input type="checkbox"/>	250WL42	–	Wheel Locks	\$105.00
Shroud Color				\$
			Color Accents	
<input type="checkbox"/>	250C119	–	Matte Black	NC
<input type="checkbox"/>	250C165	–	Candy Apple Red	\$150.00
<input type="checkbox"/>	250C166	–	Candy Blue	\$150.00
<input type="checkbox"/>	250C167	–	Candy Purple	\$150.00
<input type="checkbox"/>	250C176	–	Green Apple	\$150.00
<input type="checkbox"/>	250C178	–	Pearl Pink	\$150.00
<input type="checkbox"/>	250C182	–	Silver	\$150.00
<input type="checkbox"/>	250C170	–	American Flag	\$515.00
Color Accents				\$
<input type="checkbox"/>	250EZ20	–	Apple Green	NC
<input type="checkbox"/>	250EZ22	–	Black	NC
<input type="checkbox"/>	250EZ21	–	Blue	NC
<input type="checkbox"/>	250EZ23	–	Orange	NC
<input type="checkbox"/>	250EZ24	–	Red	NC
<input type="checkbox"/>	250EZ19	–	White	NC

BASE

OPTION	HCPC	DESCRIPTION	RETAIL
--------	------	-------------	--------

Service Decals \$

<input type="checkbox"/>	250D10	–	Army	NC
<input type="checkbox"/>	250D11	–	Air Force	NC
<input type="checkbox"/>	250D13	–	Marines	NC
<input type="checkbox"/>	250D14	–	Navy	NC
<input type="checkbox"/>	250D15	–	Purple Heart	NC

ISO Transit Tie Downs \$

<input type="checkbox"/>	250T050	–	ISO Transit Package	NC
--------------------------	---------	---	---------------------	----

LED Lights  P. 27 \$

<input type="checkbox"/>	250LI04	–	LED Lights and Indicators	\$1,200.00
<input type="checkbox"/>	250LI02	–	Omit LED Lights	NC

Seat Heights \$

Note: Available seat-to-floor heights are dependent on 2 options: **1- Battery Size** and **2- Powered Seating**.

Use the matrix below to determine available ranges for your desired options. Measured from front of seat pan to floor with 0° frame angle.

		Seat Height	Power Seating	No Power Seating		
<input type="checkbox"/>	250HT103	–	16.5"	Group 34	Group 34	NC
<input type="checkbox"/>	250HT55	–	17"	Group 34	GP24 or GP34	NC
<input type="checkbox"/>	250HT104	–	17.5"	Group 34	GP24 or GP34	NC
<input type="checkbox"/>	250HT56	–	18"	GP24 or GP34	GP24 or GP34	NC
<input type="checkbox"/>	250HT105	–	18.5"	GP24 or GP34	GP24 or GP34	NC
<input type="checkbox"/>	250HT57	–	19"	GP24 or GP34	GP24 or GP34	NC

Batteries and Chargers  P. 27 \$**Group 24 Battery Options (Recommended for max daily range)**

<input type="checkbox"/>	250AG25	E2363	GP24 Flat Top Pair w/Strap MK Gel	\$975.00
<input type="checkbox"/>	250AG26	E2363	GP24 Flat Top Pair w/Strap Brightway AGM	\$735.00

Group 34 Battery Options (Required for lower seat-to-floor heights)

<input type="checkbox"/>	250AG27	E2359	GP34 Flat Top Pair w/Straps MK Gel	\$940.00
<input type="checkbox"/>	250AG29	E2359	GP34 Flat Top Pair w/Straps Brightway AGM	\$710.00

Omit Batteries

<input type="checkbox"/>	250AG24	–	Battery Harnesses Only (Omit Batteries)	NC
--------------------------	---------	---	---	----

Chargers

<input type="checkbox"/>	250BJ28	–	10A Dual Mode (Compact)	NC
--------------------------	---------	---	-------------------------	----

POWERED SEATING

OPTION	HCPC	DESCRIPTION	RETAIL
--------	------	-------------	--------

Power Seating Options  P. 27 \$
Seat Elevator

<input type="checkbox"/>	250PI07	E2300	Seat Elevator, Powered, 300 mm / 12" <i>(Not available with HD or 8 mph motors)</i>	\$3,250.00
<input type="checkbox"/>	250PI08	E2300	C-Me® Seat Elevator, Powered, 300 mm / 12" <i>(Not available with HD or 8 mph motors)</i> <i>For users less than 250 lbs. C-Me speed can reach 3 mph.</i> <i>For users 251 to 300 lbs. C-Me speed can reach 2.4 mph.</i>	\$3,250.00

Seat Tilt

<input type="checkbox"/>	250PA35	E1002	Posterior 50° Tilt	\$7,250.00
<input type="checkbox"/>	250PA36	E1002	Posterior 50° HD Tilt	\$8,250.00

Seat Recline

<input type="checkbox"/>	250PA37	E1004	150° Powered Recline w/ 4" Shear Reduction	\$7,250.00
<input type="checkbox"/>	250PA38	–	130° Powered Semi-Recline	\$6,750.00
<input type="checkbox"/>	250PA39	E1004	150° HD Powered Recline w/ 4" Shear Reduction	\$8,250.00

Seat Tilt/Recline

<input type="checkbox"/>	250PA41	E1007	Posterior 50° Tilt and 150° Recline Powered, w/ 4" Shear Reduction	\$11,750.00
<input type="checkbox"/>	250PA42	E1002	Posterior 50° Tilt and 130° Semi-Recline Powered	\$11,250.00
<input type="checkbox"/>	250PA43	E1007	Posterior 50° HD Tilt and 150° HD Recline Powered, w/ 4" Shear Reduction	\$12,750.00

Power Recline Backrest Preset Home Angle

<input type="checkbox"/>	250QK1	–	90°	NC
<input type="checkbox"/>	250QK2	–	95° (Default Position)	NC
<input type="checkbox"/>	250QK3	–	100°	NC

Pre Set Seat Frame Angle *(No Power Seating Options, Increases Seat to Floor Height)* \$

<input type="checkbox"/>	250FA10	–	0° <i>(Adds 0" to STFH)</i>	NC
<input type="checkbox"/>	250FA3	–	3° <i>(Adds 1" to STFH)</i>	NC
<input type="checkbox"/>	250FA4	–	6° <i>(Adds 2" to STFH)</i>	NC
<input type="checkbox"/>	250FA5	–	9° <i>(Adds 3" to STFH)</i>	NC

Backrest Frame Type \$

<input type="checkbox"/>	250BF10	–	Tool Angle Adjustable Back, 90°-120°	NC
<input type="checkbox"/>	250BF11	E1225	User Adjustable Manual Semi-Recline Back, 90°-130°, Right <i>(Adjustment lever mounted on opposite side of joystick)</i>	\$585.00
<input type="checkbox"/>	250BF12	E1225	User Adjustable Manual Semi-Recline Back, 90°-130°, Left <i>(Adjustment lever mounted on opposite side of joystick)</i>	\$585.00

Backrest Frame Option \$

<input type="checkbox"/>	250BF13	–	Flip Down, Quick Release	\$125.00
--------------------------	---------	---	--------------------------	----------

Back Cushion Type \$

<input type="checkbox"/>	250BT134	–	SEDEO® Back Cushion <i>(Choose Seating in Section A)</i>	NC
<input type="checkbox"/>	250BT138	–	JAY® Syncra™ <i>(Choose Seating in Section B)</i>	NC
<input type="checkbox"/>	250BT135	–	JAY® J3® <i>(Choose Seating in Section C)</i>	NC
<input type="checkbox"/>	250BT136	–	JAY® J3® Interface Only <i>(Allows JAY Your Way modifications)</i>	NC
<input type="checkbox"/>	250BT137	–	SEDEO® PRO™ Aftermarket Back Adapter <i>(Height adjustable round tubes for traditional mounting)</i>	\$450.00
<input type="checkbox"/>	250BT133	–	OMIT <i>(For custom mounting. No headrest mount)</i>	NC

POWERED SEATING

OPTION	HCPC	DESCRIPTION	RETAIL
--------	------	-------------	--------

A - SEDEO® Backrest Dimensions

\$

Back Width

<input type="checkbox"/>	250BN28	–	400mm / 16"	NC
<input type="checkbox"/>	250BN29	–	460mm / 18"	NC
<input type="checkbox"/>	250BN30	–	500mm / 20"	NC
<input type="checkbox"/>	250BN31	–	560mm / 22"	NC

Back Shell Height

			Tool Angle Adjust.	130° Recline	150° Recline	Installed Back Height		
<input type="checkbox"/>	250B255	–	460mm / 18"	22"-23"	22"-24"		23"-25"	NC
<input type="checkbox"/>	250B256	–	560mm / 22"	24"-27"	25"-27"		26"-29"	NC
<input type="checkbox"/>	250B257	–	660mm / 26"	28"-30"	28"-30"		30"	NC

Installed Back Height - (From Pan to Top of Back)

<input type="checkbox"/>	250JR32	–	22"	NC
<input type="checkbox"/>	250JR33	–	23"	NC
<input type="checkbox"/>	250JR34	–	24"	NC
<input type="checkbox"/>	250JR35	–	25"	NC
<input type="checkbox"/>	250JR36	–	26"	NC
<input type="checkbox"/>	250JR37	–	27"	NC
<input type="checkbox"/>	250JR38	–	28"	NC
<input type="checkbox"/>	250JR39	–	29"	NC
<input type="checkbox"/>	250JR40	–	30"	NC

Lateral Thoracic Support Pads

<input type="checkbox"/>	250KD31	E0956	Lateral, Swing-Away, Adjustable, Long Pad 150 x 130 mm / 6" x 5" , Right	\$130.00
<input type="checkbox"/>	250KD32	E0956	Lateral, Swing-Away, Adjustable, Long Pad 150 x 130 mm / 6" x 5" , Left	\$130.00
<input type="checkbox"/>	250KD33	E0956	Lateral, Swing-Away, Adjustable, Short Pad 90 x 120 mm / 3.5" x 4.5" , Right	\$130.00
<input type="checkbox"/>	250KD34	E0956	Lateral, Swing-Away, Adjustable, Short Pad 90 x 120 mm / 3.5" x 4.5" , Left	\$130.00

Lateral Thoracic Swing-Away Hardware

<input type="checkbox"/>	250KE45	E1028	Lateral Swing-Away Hardware, Right	\$230.00
<input type="checkbox"/>	250KE46	E1028	Lateral Swing-Away Hardware, Left	\$230.00

POWERED SEATING

OPTION	HCPC	DESCRIPTION	RETAIL
--------	------	-------------	--------

B - JAY® Syncra™ Seating**B - JAY® Syncra™ Back**  P. 26 \$

<input type="checkbox"/>	250JP14	E2620	JAY® Syncra™ Back 16-20" Wide with 3" Contour Depth	\$975.00
<input type="checkbox"/>	250JP15	E2621	JAY® Syncra™ Back 22" Wide with 3" Contour Depth	\$1,075.00

B - JAY® Syncra™ Back Width \$

Back can be ordered a different width than seat pan. Armrest will be adjusted to back width ordered.

<input type="checkbox"/>	250JQ07	–	16" Wide (Adjustment range 16 to 17" Wide)*	NC
<input type="checkbox"/>	250JQ08	–	18" Wide (Adjustment range 18 to 19" Wide)*	NC
<input type="checkbox"/>	250JQ09	–	20" Wide (Adjustment range 20 to 21" Wide)*	NC
<input type="checkbox"/>	250JQ10	–	22" Wide (Adjustment range 22 to 23" Wide)	NC

**Additional +1" of shell width adjustment is achievable. Requires purchase of 1" larger foam and upholstery separately.*

B - JAY® Syncra™ Back Shell Options and Height Ranges \$

JAY® Syncra™ Back shells are mounted with a minimim 5.5" gap between the bottom of the shell to the seat pan to accommodate the mechanical shear. Back height can be adjusted in the field with-in the ranges shown based on the back frame type.

JAY® Syncra™ Shell Height

<input type="checkbox"/>	250JR42	–	16" Tall Shell (22" to 24" Back Height)	NC
<input type="checkbox"/>	250JR43	–	18" Tall Shell (24" to 26" Back Height)	NC
<input type="checkbox"/>	250JR44	–	20" Tall Shell (26" to 28" Back Height)	NC
<input type="checkbox"/>	250JR45	–	22" Tall Shell (28" to 30" Back Height)	NC

JAY® Syncra™ Back Installed Back Height (From Pan to Top of Back)

<input type="checkbox"/>	250JR50	–	22" (16" Shell Height)	NC
<input type="checkbox"/>	250JR51	–	23" (16" Shell Height)	NC
<input type="checkbox"/>	250JR52	–	24" (16" Shell Height)	NC
<input type="checkbox"/>	250JR53	–	24" (18" Shell Height)	NC
<input type="checkbox"/>	250JR54	–	25" (18" Shell Height)	NC
<input type="checkbox"/>	250JR55	–	26" (18" Shell Height)	NC
<input type="checkbox"/>	250JR56	–	26" (20" Shell Height)	NC
<input type="checkbox"/>	250JR57	–	27" (20" Shell Height)	NC
<input type="checkbox"/>	250JR58	–	28" (20" Shell Height)	NC
<input type="checkbox"/>	250JR67	–	28" (22" Shell Height)	NC
<input type="checkbox"/>	250JR68	–	29" (22" Shell Height)	NC
<input type="checkbox"/>	250JR69	–	30" (22" Shell Height)	NC

B - JAY® Syncra™ Back Upholstery \$

<input type="checkbox"/>	250BU96	–	Syncra™ Premium Leatherette	NC
<input type="checkbox"/>	250BU97	–	Syncra™ Stretch	NC
<input type="checkbox"/>	250BU98	–	Syncra™ 3DX Microclimatic	NC

POWERED SEATING

OPTION	HCPC	DESCRIPTION	RETAIL
--------	------	-------------	--------

B - JAY® Lateral Thoracic Swing-Away Supports (Requires Pad, Upholstery and Mount)

\$

JAY® Lateral Thoracic Support Pads

<input type="checkbox"/>	250JW35	E0956	Lateral Thoracic (L x H) 100 mm x 127 mm / 4" x 5" Pad - Right	\$125.00
<input type="checkbox"/>	250JW38	E0956	Lateral Thoracic (L x H) 100 mm x 127 mm / 4" x 5" Pad - Left	\$125.00
<input type="checkbox"/>	250JW36	E0956	Lateral Thoracic (L x H) 100 mm x 152 mm / 4" x 6" Pad - Right	\$125.00
<input type="checkbox"/>	250JW39	E0956	Lateral Thoracic (L x H) 100 mm x 52 mm / 4" x 6" Pad - Left	\$125.00
<input type="checkbox"/>	250JW37	E0956	Lateral Thoracic (L x H) 152 mm x 100 mm / 6" x 4" Pad - Right	\$125.00
<input type="checkbox"/>	250JW40	E0956	Lateral Thoracic (L x H) 152 mm x 100 mm / 6" x 4" Pad - Left	\$125.00

JAY® Lateral Thoracic Support Pad Upholstery

<input type="checkbox"/>	250NU01	–	Syncra™ Premium Leatherette	NC
<input type="checkbox"/>	250NU02	–	Syncra™ Stretch	NC
<input type="checkbox"/>	250NU03	–	Syncra™ 3DX Microclimatic	NC

JAY® Lateral Thoracic Swing-Away Mount

<input type="checkbox"/>	250JW41	E1028	Lateral Thoracic Swing Away Bracket - Right	\$250.00
<input type="checkbox"/>	250JW42	E1028	Lateral Thoracic Swing Away Bracket - Left	\$250.00

B - JAY® Syncra™ Fixed Lateral Support Accessory

\$

JAY® Fixed Lateral Support Accessory Hardware (JAY® Fixed Lateral Support is height adjustable)

<input type="checkbox"/>	250JW33	E0956	Fixed Lateral Support Accessory (L x H) 90 mm x 140 mm / 3.5" x 8" - Right	\$125.00
<input type="checkbox"/>	250JW34	E0956	Fixed Lateral Support Accessory (L x H) 90 mm x 140 mm / 3.5" x 8" - Left	\$125.00

POWERED SEATING

OPTION	HCPC	DESCRIPTION	RETAIL
--------	------	-------------	--------

C - JAY® J3® Back**C - JAY® J3® Back - Contour**  P. 27

\$

<input type="checkbox"/>	250JP01	E2613	J3® PA Back for 14"-20" Wide	\$535.00
<input type="checkbox"/>	250JP02	E2614	J3® PA Back for 22" Wide	\$795.00
<input type="checkbox"/>	250JP11	E2615	J3® PL Back for 14"-20" Wide	\$625.00
<input type="checkbox"/>	250JP13	E2620	J3® PD Back for 14"-20" Wide (18" and 21" shell height only)	\$750.00

C - JAY® J3® Back Width

\$

Back can be ordered a different width than seat pan. Armrest will be adjusted to back width ordered.

<input type="checkbox"/>	250JQ02	–	16"	NC
<input type="checkbox"/>	250JQ03	–	18"	NC
<input type="checkbox"/>	250JQ04	–	20"	NC
<input type="checkbox"/>	250JQ05	–	22"	NC

C - JAY® J3® Back Shell Options and Height Ranges

\$

JAY® J3® shells are mounted with a minimim 4" gap between the bottom of the shell to the seat pan to accommodate the mechanical shear. Back height can be adjusted in the field within the ranges shown, based on the back frame type and the amount of usable hardware adjustability.

JAY® J3® Shell Height

			Tool Angle Adjust.	130° Recline	150° Recline	Installed Back Height		
<input type="checkbox"/>	250JR41	–	15" tall shell (Upper Thoracic Med) for 22" Wide	22"-23"	21"-22"		22"-23"	NC
<input type="checkbox"/>	250JR14	–	16.5" tall shell (Upper Thoracic Short)	21"-23"	22"-23"		22"-24"	NC
<input type="checkbox"/>	250JR15	–	18" tall shell (Upper Thoracic Med)	22"-24"	22"-24"		23"-25"	NC
<input type="checkbox"/>	250JR16	–	19.5" tall shell (Upper Thoracic Tall)	24"-26"	24"-26"		24"-26"	NC
<input type="checkbox"/>	250JR18	–	18" tall shell (Shoulder Height) for 22" wide	24"	23"		24"	NC
<input type="checkbox"/>	250JR17	–	21" tall shell (Shoulder Height)	24"-26"	25"-27"		25"-28"	NC
<input type="checkbox"/>	250JR27	–	22.5" tall shell (Shoulder Height)	26"-28"	27"-29"		27"-30"	NC
<input type="checkbox"/>	250JR28	–	24" tall shell (Shoulder Height)	27"-29"	28"-30"		28"-30"	NC

JAY® J3® Installed Back Height (From Pan to Top of Back)

<input type="checkbox"/>	250JR29	–	21"	NC
<input type="checkbox"/>	250JR19	–	22"	NC
<input type="checkbox"/>	250JR20	–	23"	NC
<input type="checkbox"/>	250JR21	–	24"	NC
<input type="checkbox"/>	250JR22	–	25"	NC
<input type="checkbox"/>	250JR23	–	26"	NC
<input type="checkbox"/>	250JR24	–	27"	NC
<input type="checkbox"/>	250JR25	–	28"	NC
<input type="checkbox"/>	250JR30	–	29"	NC
<input type="checkbox"/>	250JR31	–	30"	NC

POWERED SEATING

OPTION	HCPC	DESCRIPTION	RETAIL
--------	------	-------------	--------

C - JAY® J3® Back Spine-Align Fit Kit 2  P. 27 \$

<input type="checkbox"/>	250JS02	K0108	410 mm / 16"	\$139.00
<input type="checkbox"/>	250JS03	K0108	460 mm / 18"	\$139.00
<input type="checkbox"/>	250JS04	K0108	510 mm / 20"	\$139.00

C - JAY® Anterior Thoracic Support  P. 27 \$*Classic-Structure Pull Down Harness (4 point strap, only available with JAY® backrest)*

<input type="checkbox"/>	250K10	E0960	Medium (ATS8302)	\$152.00
<input type="checkbox"/>	250K11	E0960	Large (ATS8303)	\$152.00
<input type="checkbox"/>	250K12	E0960	Extra Large (ATS8304)	\$152.00

C - JAY® J3® Lateral Thoracic Swing-Away Supports \$**Lateral Thoracic Support Pads**

<input type="checkbox"/>	250JW19	E0956	Lateral Thoracic (LxH) 100 mm x 100 mm / 4" x 4" Pad - Right	\$125.00
<input type="checkbox"/>	250JW25	E0956	Lateral Thoracic (LxH) 100 mm x 100 mm / 4" x 4" Pad - Left	\$125.00
<input type="checkbox"/>	250JW20	E0956	Lateral Thoracic (LxH) 100 mm x 127 mm / 4"x 5" Pad - Right	\$125.00
<input type="checkbox"/>	250JW26	E0956	Lateral Thoracic (LxH) 100 mm x 127 mm / 4"x 5" Pad - Left	\$125.00
<input type="checkbox"/>	250JW21	E0956	Lateral Thoracic (LxH) 100 mm x 152 mm / 4" x 6" Pad - Right	\$125.00
<input type="checkbox"/>	250JW27	E0956	Lateral Thoracic (LxH) 100 mm x 152 mm / 4" x 6" Pad - Left	\$125.00
<input type="checkbox"/>	250JW22	E0956	Lateral Thoracic (LxH) 152 mm x 100 mm / 6" x 4" Pad - Right	\$125.00
<input type="checkbox"/>	250JW28	E0956	Lateral Thoracic (LxH) 152 mm x 100 mm / 6" x 4" Pad - Left	\$125.00
<input type="checkbox"/>	250JW23	E0956	Lateral Thoracic (LxH) 152 mm x 127 mm / 6" x 5" Pad - Right	\$125.00
<input type="checkbox"/>	250JW29	E0956	Lateral Thoracic (LxH) 152 mm x 127 mm / 6" x 5" Pad - Left	\$125.00
<input type="checkbox"/>	250JW24	E0956	Lateral Thoracic (LxH) 152 mm x 152 mm / 6" x 6" Pad - Right	\$125.00
<input type="checkbox"/>	250JW30	E0956	Lateral Thoracic (LxH) 152 mm x 152 mm / 6" x 6" Pad - Left	\$125.00

Lateral Thoracic Swing-Away Hardware

<input type="checkbox"/>	250JW31	E1028	Lateral Thoracic Swing-Away Bracket - Right	\$263.00
<input type="checkbox"/>	250JW32	E1028	Lateral Thoracic Swing-Away Bracket - Left	\$263.00

Headrests (Requires Pad, Upholstery, & Mount)  P. 29 \$**Headrest Pad**

<input type="checkbox"/>	250HE36	E0955	SEDEO® Pad Small With Cover (LxH) 240 x 150 mm / 10" x 6" <i>Can only be used with Multi Position Headrest Mount with Quick Release and SEDEO® Upholstery</i>	\$161.00
<input type="checkbox"/>	250HE37	E0955	SEDEO® Pad Flexible, (LxH) 400 x 110 mm / 16" x 4.5" <i>Can only be used with Multi Position Headrest Mount with Quick Release and SEDEO® Upholstery</i>	\$260.00
<input type="checkbox"/>	250HE38	E0955	Whitmyer® Plush Headrest Pad 203 mm / 8"	\$205.00
<input type="checkbox"/>	250HE39	E0955	Whitmyer® Plush Headrest Pad 254 mm / 10"	\$205.00
<input type="checkbox"/>	250HE44	E0955	Whitmyer® Plush Headrest Pad 356 mm / 14"	\$215.00
<input type="checkbox"/>	250HE45	E0955	Whitmyer® Adjust-A-Plush Headrest Pad Small (Narrow) (Adjustable from 6 to 14" Wide x 3" Tall)	\$315.00
<input type="checkbox"/>	250HE46	E0955	Whitmyer® Adjust-A-Plush Headrest Pad Medium (Adjustable from 7 to 16" Wide x 4" Tall)	\$315.00
<input type="checkbox"/>	250HE47	E0955	Whitmyer® Adjust-A-Plush Headrest Pad Large (Standard) (Adjustable from 8 to 18" Wide x 5" Tall)	\$315.00
<input type="checkbox"/>	250HE48	–	OMIT Headrest Pad	NC

POWERED SEATING

OPTION	HCPC	DESCRIPTION	RETAIL
Headrest Pad Upholstery			
<input type="checkbox"/> 250NU10	–	SEDEO® Upholstery	NC
<input type="checkbox"/> 250NU04	–	Syncra™ Premium Leatherette	NC
<input type="checkbox"/> 250NU05	–	Syncra™ Stretch	NC
<input type="checkbox"/> 250NU06	–	Syncra™ 3DX Microclimatic	NC
<input type="checkbox"/> 250NU11	–	Whitmyer® Lycra	NC
Headrest Mount			
<input type="checkbox"/> 250MH32	E1028	SEDEO® Multi-Position Headrest Mount with Quick Release <i>(Only available with SEDEO® Pad)</i>	\$200.00
<input type="checkbox"/> 250MH33	E1028	Whitmyer® Linx Headrest Mount with Quick Release	\$165.00
<input type="checkbox"/> 250MH34	E1028	Whitmyer® Linx-2 Headrest Mount with Quick Release	\$200.00
<input type="checkbox"/> 250MH35	E1028	Whitmyer® AXYS Headrest Mount with Quick Release	\$105.00
<input type="checkbox"/> 250MH36	E1028	Whitmyer® AXYS Offset Headrest Mount with Quick Release	\$125.00
<input type="checkbox"/> 250MH37	E1028	Whitmyer® Cobra FB Headrest Mount with Quick Release	\$300.00
<input type="checkbox"/> 250MH17	–	OMIT Headrest Mount	NC
Push Handles			\$
<input type="checkbox"/> 250PH27	–	Height Adjustable Push Handles	\$300.00
Seat Frame Rails			\$
<input type="checkbox"/> 250SN14	–	Seat Rail Short <i>(For effective seat depth 14" to 18")</i>	NC
<input type="checkbox"/> 250SN15	–	Seat Rail Long <i>(For effective seat depth 17" to 20")</i>	NC
Seat Cushion Type			\$
<input type="checkbox"/> 250ST79	–	SEDEO® (See Section D)	NC
<input type="checkbox"/> 250ST81	–	JAY® Syncra™ Cushion (See Section E)	NC
<input type="checkbox"/> 250ST80	–	JAY® (See Section F)	NC
<input type="checkbox"/> 250ST75	–	Omit	NC
C - Seat Size			\$
Seat Pan Width <i>(Odd sizes not available on SEDEO® cushions)</i>			
<input type="checkbox"/> 250R53	–	16"	NC
<input type="checkbox"/> 250R54	–	17"	NC
<input type="checkbox"/> 250R55	–	18"	NC
<input type="checkbox"/> 250R56	–	19"	NC
<input type="checkbox"/> 250R57	–	20"	NC
<input type="checkbox"/> 250R58	–	21" <i>(Not available with JAY® Syncra™ Cushions)</i>	NC
<input type="checkbox"/> 250R59	–	22"	NC

POWERED SEATING

OPTION	HCPC	DESCRIPTION	RETAIL
Seat Pan Depth (Front of seat pan to front of back cushion – effective depth)			
<input type="checkbox"/> 250RF52	–	14"	NC
<input type="checkbox"/> 250RF53	–	15"	NC
<input type="checkbox"/> 250RF51	–	16"	NC
<input type="checkbox"/> 250RF45	–	17"	NC
<input type="checkbox"/> 250RF46	–	18"	NC
<input type="checkbox"/> 250RF47	–	19"	NC
<input type="checkbox"/> 250RF48	–	20"	NC
<input type="checkbox"/> 250RF49	–	21" (Not available with JAY® Syncra™ Cushions)	NC
<input type="checkbox"/> 250RF50	–	22"	NC

D - SEDEO® Cushions  P. 27 **\$**

<input type="checkbox"/> 250CU82	E2607	SEDEO® Cushion (Sizes 16", 18", & 20" Wide) (Not available with 14" Depth)	\$395.00
<input type="checkbox"/> 250CU83	E2608	SEDEO® Cushion (Size 22" Wide)	\$495.00

E - JAY® Syncra™ Cushion  P. 26 (JAY Your Way modifications available through Customer Service (800) 333-4000) **\$**

<input type="checkbox"/> 250CU87	E2607	JAY® Syncra™ Cushion with Visco Foam (16" to 20" wide)	\$415.00
<input type="checkbox"/> 250CU88	E2608	JAY® Syncra™ Cushion with Visco Foam (22" wide)	\$490.00
<input type="checkbox"/> 250CU89	E2622	JAY® Syncra™ Cushion featuring JAY Flow® Fluid with Cryo™ Technology (16" to 20" wide)	\$540.00
<input type="checkbox"/> 250CU90	E2623	JAY® Syncra™ Cushion featuring JAY Flow® Fluid with Cryo™ Technology (22" wide)	\$625.00
<input type="checkbox"/> 250CU91	E2622	JAY® Syncra™ Cushion with Air Insert - Single Valve (16" to 20" wide)	\$495.00
<input type="checkbox"/> 250CU92	E2623	JAY® Syncra™ Cushion with Air Insert - Single Valve (22" wide)	\$580.00
<input type="checkbox"/> 250CU93	E2622	JAY® Syncra™ Cushion with Air Insert - Dual Valve (16" to 20" wide)	\$500.00
<input type="checkbox"/> 250CU94	E2623	JAY® Syncra™ Cushion with Air Insert - Dual Valve (22" wide)	\$585.00

JAY® Syncra™ Cushion Cover Upholstery

<input type="checkbox"/> 250YR73	–	Syncra™ Premium Leatherette	NC
<input type="checkbox"/> 250YR74	–	Syncra™ Stretch	NC
<input type="checkbox"/> 250YR75	–	Syncra™ 3DX Microclimatic	NC

POWERED SEATING

OPTION	HCPC	DESCRIPTION	RETAIL
F - JAY® Seat Cushion  P. 28			\$
<input type="checkbox"/>	250CU55	E2622 JAY® X2® Cushion (Sizes 16" - 20" Wide)	\$425.00
<input type="checkbox"/>	250CU56	E2622 JAY® J2® Cushion (Sizes 16" - 20" Wide)	\$435.00
<input type="checkbox"/>	250CU57	E2622 JAY® J2® Deep Contour Cushion (Sizes 16" - 20" Wide)	\$450.00
<input type="checkbox"/>	250CU58	E2623 JAY® J2® Deep Contour Cushion (Size 22" Wide)	\$555.00
<input type="checkbox"/>	250CU59	E2607 JAY® Ion® (Sizes 16" - 21" Wide)	\$395.00
<input type="checkbox"/>	250CU60	E2608 JAY® Ion® (Size 22" Wide)	\$495.00
<input type="checkbox"/>	250CU61	E2607 JAY® Union® (Sizes 16" - 21" Wide)	\$445.00
<input type="checkbox"/>	250CU62	E2608 JAY® Union® (Size 22" Wide)	\$545.00
<input type="checkbox"/>	250CU63	E2607 JAY® Union® Reduced Profile (Sizes 16" - 20" Wide)	\$445.00
<input type="checkbox"/>	250CU64	E2622 JAY® Fusion® (Sizes 16" - 21" Wide)	\$440.00
<input type="checkbox"/>	250CU65	E2623 JAY® Fusion® (Size 22" Wide)	\$525.00
<input type="checkbox"/>	250CU66	E2622 JAY® Fusion® Air Insert Single Valve (Sizes 16" - 21" Wide)	\$495.00
<input type="checkbox"/>	250CU67	E2623 JAY® Fusion® Air Insert Single Valve (Size 22" Wide)	\$580.00
<input type="checkbox"/>	250CU68	E2622 JAY® Fusion® Air Insert Dual Valve (Sizes 16" - 21" Wide)	\$500.00
<input type="checkbox"/>	250CU69	E2623 JAY® Fusion® Air Insert Dual Valve (Size 22" Wide)	\$585.00
<input type="checkbox"/>	250CU70	E2622 JAY® Fusion® Reduced Profile (Sizes 16" - 21" Wide)	\$440.00
<input type="checkbox"/>	250CU71	E2623 JAY® Fusion® Reduced Profile (Size 22" Wide)	\$525.00
<input type="checkbox"/>	250CU72	E2622 JAY® Fusion® Reduced Profile Air Insert Single Valve (Sizes 16" - 21" Wide)	\$495.00
<input type="checkbox"/>	250CU73	E2623 JAY® Fusion® Reduced Profile Air Insert Single Valve (Size 22" Wide)	\$580.00
<input type="checkbox"/>	250CU74	E2622 JAY® Fusion® Reduced Profile Air Insert Dual Valve (Sizes 16" - 21" Wide)	\$500.00
<input type="checkbox"/>	250CU75	E2623 JAY® Fusion® Reduced Profile Air Insert Dual Valve (Size 22" Wide)	\$585.00
<input type="checkbox"/>	250CU76	E2624 JAY® Fusion® Positioning (Sizes 16" - 21" Wide)	\$460.00
<input type="checkbox"/>	250CU77	E2625 JAY® Fusion® Positioning (Size 22" Wide)	\$545.00
<input type="checkbox"/>	250CU78	E2624 JAY® Fusion® Positioning Air Insert Single Valve (Sizes 16" - 21" Wide)	\$515.00
<input type="checkbox"/>	250CU79	E2625 JAY® Fusion® Positioning Air Insert Single Valve (Size 22" Wide)	\$600.00
<input type="checkbox"/>	250CU80	E2624 JAY® Fusion® Positioning Air Insert Dual Valve (Sizes 16" - 21" Wide)	\$520.00
<input type="checkbox"/>	250CU81	E2625 JAY® Fusion® Positioning Air Insert Dual Valve (Size 22" Wide)	\$605.00

F - JAY® Solid Seat**\$**

<input type="checkbox"/>	250CU84	–	JAY® Solid Seat	\$85.00
--------------------------	---------	---	-----------------	---------

F - JAY® Bundling**\$**

Note: To order any JAY® cushion not listed above please see the JAY® price list.

<input type="checkbox"/>	250JC20	–	JAY® Bundled Cushion	See Price List
			Cushion name or part number	Width
				Depth

POSITIONING SUPPORTS & ACCESSORIES

OPTION	HCPC	DESCRIPTION	RETAIL
Knee and Thigh Swing-Away Support Pads			\$
Lateral Knee Support Pads and Hardware (must pick pad and mount)			
<input type="checkbox"/>	250XY05	E0953 Lateral Knee Support Pad, Right (4" round)	\$175.00
<input type="checkbox"/>	250XY06	E0953 Lateral Knee Support Pad, Left (4" round)	\$175.00
<input type="checkbox"/>	250XX08	E1028 Lateral Swing-Away Bracket Knee - Right	\$230.00
<input type="checkbox"/>	250XX09	E1028 Lateral Swing-Away Bracket Knee - Left	\$230.00
Lateral Thigh Support Pads and Hardware (must pick pad and mount)			
<input type="checkbox"/>	250KF08	E0953 Lateral Thigh Support Pad, Right (5"x10")	\$105.00
<input type="checkbox"/>	250KF09	E0953 Lateral Thigh Support Pad, Left (5"x10")	\$105.00
<input type="checkbox"/>	250KF10	E1028 Lateral Removable Bracket Thigh - Right	\$230.00
<input type="checkbox"/>	250KF11	E1028 Lateral Removable Bracket Thigh - Left	\$230.00
JAY® Lateral Thigh Supports (Must pick pad, upholstery, and mount)			\$
JAY® Lateral Thigh Support Pads			
<input type="checkbox"/>	250KF16	E0953 Lateral Thigh Support Pad Standard, Right (8.25" x 3.25")	\$125.00
<input type="checkbox"/>	250KF17	E0953 Lateral Thigh Support Pad Standard, Left (8.25" x 3.25")	\$125.00
<input type="checkbox"/>	250KF18	E0953 Lateral Thigh Support Pad Large, Right (12" x 3.25")	\$125.00
<input type="checkbox"/>	250KF19	E0953 Lateral Thigh Support Pad Large, Left (12" x 3.25")	\$125.00
JAY® Lateral Thigh Support Pad Upholstery			
<input type="checkbox"/>	250NU07	– Syncra™ Premium Leatherette	NC
<input type="checkbox"/>	250NU08	– Syncra™ Stretch	NC
<input type="checkbox"/>	250NU09	– Syncra™ 3DX Microclimatic	NC
JAY® Lateral Thigh Removable Mount			
<input type="checkbox"/>	250KF20	E1028 Lateral Thigh Removable Mount - Right	\$250.00
<input type="checkbox"/>	250KF21	E1028 Lateral Thigh Removable Mount - Left	\$250.00

POSITIONING SUPPORTS & ACCESSORIES

OPTION	HCPC	DESCRIPTION	RETAIL
Armrest Structure  P. 28			\$
<input type="checkbox"/> 250EG35	–	Reclining, Flip Back (<i>Height Adjustable 9" to 15"</i>)	NC
<input type="checkbox"/> 250EG36	–	Reclining, Flip Back with 2-point post locking arm (<i>Height Adjustable 11" to 15" x .625"</i>)	\$250.00
<input type="checkbox"/> 250EG32	–	Single Post, Flip Back (<i>N/A with thigh support</i>), (<i>Height Adjustable 10" to 15"</i>)	NC
<input type="checkbox"/> 250EG33	–	Single Post, Removable (<i>N/A with thigh support</i>), (<i>Height Adjustable 10" to 15"</i>)	NC
Arm Pads  P. 28			\$
SEDEO® Armrest Pad			
<input type="checkbox"/> 250AB43	–	300 mm / 12", Integral Foam, Right	NC
<input type="checkbox"/> 250AE43	–	300 mm / 12", Integral Foam, Left	NC
<input type="checkbox"/> 250AB44	–	400 mm / 16", Integral Foam, Right	NC
<input type="checkbox"/> 250AE44	–	400 mm / 16", Integral Foam, Left	NC
<input type="checkbox"/> 250AB45	–	Wide, 450 mm / 18", Integral Foam, Right (<i>Increases armpad width by 1.5". May prevent flip-back.</i>)	NC
<input type="checkbox"/> 250AE45	–	Wide, 450 mm / 18", Integral Foam, Left (<i>Increases armpad width by 1.5". May prevent flip-back.</i>)	NC
Comfort Arm Pad (Foam)			
<input type="checkbox"/> 250AB46	–	2" Wide Right	\$75.00
<input type="checkbox"/> 250AE46	–	2" Wide Left	\$75.00
<input type="checkbox"/> 250AB47	–	4" Wide Right	\$75.00
<input type="checkbox"/> 250AE47	–	4" Wide Left	\$75.00
Comfort Arm Pad (Gel)			
<input type="checkbox"/> 250AB48	–	2" Wide Right	\$150.00
<input type="checkbox"/> 250AE48	–	2" Wide Left	\$150.00
<input type="checkbox"/> 250AB49	–	4" Wide Right	\$150.00
<input type="checkbox"/> 250AE49	–	4" Wide Left	\$150.00
AES Trough/Elbow Block Arm Pads (Gel)			
<input type="checkbox"/> 250AB50	E2209	3.5" x 13" Right	\$250.00
<input type="checkbox"/> 250AE50	E2209	3.5" x 13" Left	\$250.00
<input type="checkbox"/> 250AB51	E2209	4" x 14.5" Right	\$250.00
<input type="checkbox"/> 250AE51	E2209	4" x 14.5" Left	\$250.00

POSITIONING SUPPORTS & ACCESSORIES

OPTION	HCPC	DESCRIPTION	RETAIL	
Side Guards (Pair)			\$	
<input type="checkbox"/>	250SG43	E0953	Side Guards (9"L x 5.5"H) (N/A with Reclining Armrests)	\$175.00
<input type="checkbox"/>	250SG44	E0953	Side Guards Integral Foam (11"L x 5.5"H) (N/A with Reclining Armrests)	\$205.00
<input type="checkbox"/>	250SG45	E0953	Side Guards Wedge Shaped, Padded (18"L x 5"H, 3" thick in front, 1.5" thick in rear) (Only with Single Post Removable Armrests)	\$205.00
<input type="checkbox"/>	250SG46	E0953	Side Guards Mounted On Seat Rail Bracket (Only with Reclining Armrests) (N/A with Thigh Supports)	\$225.00
Fixed Centermount Legrest			\$	
<input type="checkbox"/>	250H183	–	SEDEO® Fixed Centermount Legrest (3" to 17.5" Leg Length)	\$250.00
<input type="checkbox"/>	250H184	–	Fixed Centermount Legrest, Short (Includes Calf Pads & Single Footplate) (11.5" to 14.5" Leg Length)	NC
<input type="checkbox"/>	250H185	–	Fixed Centermount Legrest, Long (Includes Calf Pads & Single Footplate) (13.5" to 18.5" Leg Length)	NC
Power Centermount Legrest  P. 28			\$	
<input type="checkbox"/>	250H175	E1012	Power Centermount Legrest, 90° - 0° Angle, 7.5" Extension (Mechanical Articulation) (5" to 17.5" Leg Length)	\$2,320.00
<input type="checkbox"/>	250H109	E1012	Power Centermount Legrest, 90° - 0° Angle, 7.5" Extension (Powered Articulation) (3" to 17.5" Leg Length)	\$3,250.00
Power Centermount Legrest Accessories			\$	
Footplates				
<input type="checkbox"/>	250F127	K0040	Dual, Height, Width and Angle Adjustable, Standard (14"W x 10"D)	\$170.00
<input type="checkbox"/>	250F128	K0040	Dual, Height, Width and Angle Adjustable, Large (16"W x 12"D)	\$170.00
Calf Pad Options				
<input type="checkbox"/>	250DI34	–	Calf Pads, Pair, Standard	NC
<input type="checkbox"/>	250DI35	E0995	Extra Large Pair Calf Pads for Centermount Legrests. Fully adjustable (N/A w/ Std footplate)	\$350.00
SEDEO® PRO™ Swing-Away Legrest (Pair)			\$	
<input type="checkbox"/>	250H177	–	Legrests, Swing-Away, 70°, SEDEO® PRO™ (14" to 21" Leg Length)	NC
<input type="checkbox"/>	250H178	E0990	Legrests, Manual Elevating, Swing-Away, SEDEO® PRO™ (Includes Padded Calf Pads) (14".5 to 21.5" Leg Length)	\$350.00
<input type="checkbox"/>	250H179	E1010	Legrests, Power Elevating, Swing-Away, SEDEO® PRO™ (Includes Padded Calf Pads) (15.5" to 22.5" Leg Length)	\$2,150.00
<input type="checkbox"/>	250H180	–	Hanger Receivers Only, SEDEO® PRO™	NC
<input type="checkbox"/>	250DI76	–	Omit Legrests	NC
Swing-Away Legrest Footplates				
<input type="checkbox"/>	250F360	K0040	Footplate, For Seat Width 15" - 16"	\$170.00
<input type="checkbox"/>	250F361	K0040	Footplate, For Seat Width 17" - 18"	\$170.00
<input type="checkbox"/>	250F362	K0040	Footplate, For Seat Width 19" - 20"	\$170.00
<input type="checkbox"/>	250F363	K0040	Footplate, For Seat Width 21" - 22"	\$170.00
Swing-Away Legrest Calf Supports				
<input type="checkbox"/>	250DI41	–	Calf Support, Depth Adjustable, Integral Foam (7" Wide x 10" Tall, NA 16-17" W)	\$295.00
<input type="checkbox"/>	250DI42	–	Calf Support, Depth Adjustable, Padded (6.5" to 8" Wide, Depending On Chair Width, x 9.5" Tall)	\$395.00
Swing-Away Legrest Options				
<input type="checkbox"/>	250F364	K0108	Footplates, Coupled	\$250.00
<input type="checkbox"/>	250DI44	E0951	Heel Loops	\$50.00
<input type="checkbox"/>	250DI40	–	Calf Strap (Only For 70° Swing-Away Legrests)	\$100.00
<input type="checkbox"/>	250KG4	–	Knee Pads, Integral Foam (2.5" Wide x 4.5" Tall)	\$200.00
SEDEO® Lower Extremity Swing-Away Support				
<input type="checkbox"/>	250VD01	E1020	Lower Extremity Support, Padded, Swing-Away, SEDEO®, Right	\$395.00
<input type="checkbox"/>	250VD02	E1020	Lower Extremity Support, Padded, Swing-Away, SEDEO®, Left	\$395.00

POSITIONING SUPPORTS & ACCESSORIES

OPTION	HCPC	DESCRIPTION	RETAIL	
Pelvic Positioning Belts  P. 29				
<input type="checkbox"/>	250A837	–	Positioning Belt, Auto Style Buckle, 50 mm 1600 mm / 2"	NC
<input type="checkbox"/>	250A839	–	Positioning Belt, Aircraft Buckle, 50 mm x 1300 mm / 2"	NC
<input type="checkbox"/>	250A840	E0978	Positioning Belt, Aircraft Buckle, Padded 50 mm x 1300 mm / 2"	\$250.00
Accessories \$				
Ventilator Option				
<input type="checkbox"/>	250VT12	E1029	Vent Tray Fixed (<i>Pulmonetic LTV Models</i>)	\$465.00
O2 Tank Option				
<input type="checkbox"/>	250A718	E2208	O2 Tank Holder Mounted to Backrest (<i>D and E Styles</i>)	\$325.00
Wheelchair Tray Table				
<input type="checkbox"/>	2507A09	E0950	Tray, Swing-Away	\$350.00
Backpack				
<input type="checkbox"/>	250A1	–	Black Utility	\$55.00
Misc. Accessories				
<input type="checkbox"/>	2508A59	–	Transfer Bar (<i>Pair</i>)	\$350.00
<input type="checkbox"/>	2508A52	–	Ram Mount Phone	\$85.00
<input type="checkbox"/>	2508A53	–	Ram Mount Tablet	\$350.00
<input type="checkbox"/>	2508A54	–	Ram Mount Cup Holder	\$85.00
<input type="checkbox"/>	2508A58	–	Rear View Mirror	\$85.00



JOYSTICK / ELECTRONICS

OPTION	HCPC	DESCRIPTION	RETAIL	
R-net Joystick (Remote)  P. 29 \$				
<input type="checkbox"/>	250J121	–	Std LED Joystick for R-net Controls	NC
<input type="checkbox"/>	250J116	–	Color LCD (CJSM1)	NC
<input type="checkbox"/>	250J117	–	Color LCD, Heavy Duty (<i>Fixed Joystick Mount Only</i>)	\$1,150.00
<input type="checkbox"/>	250J118	–	High Resolution Color LCD, (CJSM2+BT) <i>3.5" Color Display, Paddle Switches, Programmable Shortcut Keys, ICONs, Stereo Jack, IR and dual (IOS/Android) Bluetooth control</i>	\$1,055.00
<input type="checkbox"/>	250J119	–	Omit Remote Control (<i>Required with arm mounted specialty controls</i>)	–\$25.00
Joystick Mounting \$				
<input type="checkbox"/>	250JM34	–	Fixed on Armrest	NC
<input type="checkbox"/>	250JM35	E1028	Parallel Swing-Away Capsulated on Armrest	\$295.00
<input type="checkbox"/>	250JM36	E1028	Link-It Mid Line Mount on Armrest (<i>Swing-Away</i>)	\$850.00
Joystick Mount (Location) \$				
<input type="checkbox"/>	250HM16	–	Right Hand Armrest	NC
<input type="checkbox"/>	250HM17	–	Left Hand Armrest	NC
Display Language Selection R-net \$				
<input type="checkbox"/>	250L1	–	English	NC
<input type="checkbox"/>	250L3	–	French	NC
<input type="checkbox"/>	250L7	–	Spanish	NC

JOYSTICK / ELECTRONICS

OPTION	HCPC	DESCRIPTION	RETAIL	
Joystick Handle (Optional) <i>N/A with HD Joystick</i>  P. 29			\$	
<input type="checkbox"/>	250JH13	E2323	Ball Handle	\$125.00
<input type="checkbox"/>	250JH14	E2323	Foam Ball Handle	\$125.00
<input type="checkbox"/>	250JH15	E2323	T-Handle	\$125.00
<input type="checkbox"/>	250JH16	E2323	Goalpost	\$125.00
Table Top Controls			\$	
<input type="checkbox"/>	250G09	K0108	Table Top Control LCD Remote Control, Center Tray Mounted, Included	\$2,500.00
Electronic Programmers  P. 30			\$	
<input type="checkbox"/>	250PR10	–	R-net PC Programmer w/ Dongle	\$525.00
R-net Power Modules  P. 30			\$	
<input type="checkbox"/>	250ER11	–	Power Module, R-net, 120A, Non-Expandable <i>(Only available with Group 4)</i>	NC
<input type="checkbox"/>	250ER10	–	Power Module, R-net, 120A, Expandable <i>(Only available with Group 4)</i> <i>Required for specialty controls or 2+ actuators</i>	\$1,245.00
	250EX09	E2377	Expandable 120A Controller - R-net	\$655.00
	250EX10	E2313	Harness for 120A Expandable Controller	\$590.00
<input type="checkbox"/>	250ER18	–	Power Module, R-net, 90A, Non-Expandable	NC
<input type="checkbox"/>	250ER17	–	Power Module, R-net, 90A, Expandable <i>Required for specialty controls or 2+ actuators</i>	\$1,245.00
	250EX15	E2377	Expandable 90A Controller - R-net	\$655.00
	250EX16	E2313	Harness for 90A Expandable Controller	\$590.00
Seating Control (Button Switches will not be mounted)			\$	
Switch Control Only				
<input type="checkbox"/>	250E033	–	Dual Toggle for 1 Actuator	NC
<input type="checkbox"/>	250E034	–	Buddy Button for 1 Actuator	NC
<input type="checkbox"/>	250E035	–	Switch-It Mini 1 button for 1 Actuator	NC
<input type="checkbox"/>	250E036	–	Switch-It Mini 2 button for 1 Actuator	NC
Toggle Mount				
<input type="checkbox"/>	250TN1	–	Toggle Mount, Right	NC
<input type="checkbox"/>	250TN2	–	Toggle Mount, Left	NC
Thru-Drive Control				
<input type="checkbox"/>	250E037	E2310	Thru-drive Control for 1 Actuator	\$1,920.00
<input type="checkbox"/>	250E038	E2311	Thru-drive Control for 2+ Actuators	\$3,475.00
Attendant Controls  P. 30			\$	
<input type="checkbox"/>	2500A05	E2331	Dual Control Module for Attendant	\$1,300.00
<input type="checkbox"/>	2500A06	E2331	R-net Color LCD (CJSM1) Control Attendant Only	\$1,300.00
Attendant Mounting Location			\$	
<input type="checkbox"/>	250DN5	–	Right Back Cane	NC
<input type="checkbox"/>	250DN6	–	Left Back Cane	NC

JOYSTICK / ELECTRONICS

OPTION	HCPC	DESCRIPTION	RETAIL	
Ctrl+5® Switchbox Options			\$	
<input type="checkbox"/>	250QG11	–	Ctrl+5 Switch Box With Free Assignable Functions	\$1,250.00
<input type="checkbox"/>	250QG12	–	Ctrl+5 Switch Box With Free Assignable Functions <i>(Multi-power only)</i>	NC
Ctrl+5 Mounting location				
<input type="checkbox"/>	250EY19	–	Right Armrest	NC
<input type="checkbox"/>	250EY20	–	Left Armrest	NC
<input type="checkbox"/>	250EY21	–	Back Cane, Right	\$150.00
<input type="checkbox"/>	250EY24	–	Back Cane, Left	\$150.00
Ctrl+5® Switch Type  P. 30			\$	
<input type="checkbox"/>	250EY22	–	Push Buttons	NC
<input type="checkbox"/>	250EY23	K0108	Toggle Switches	\$300.00
R-net Programming Selection			\$	
Assignable Buttons				
<i>Assignable Button feature allows for customization of joystick buttons and/or Ctrl+5 Switches allowing access to various wheelchair and seating functions. When enabled, chair will be pre-programmed with seating functions assigned to buttons on the joystick. Assignments can be changed via PC Dongle.</i>				
<input type="checkbox"/>	250PM12	–	Include Assignable Buttons	NC
<input type="checkbox"/>	250PM13	–	Omit Assignable Buttons	NC
Power Centermount Footplate Extension Option				
<input type="checkbox"/>	250IE03	K0108	Include 7.5" Powered Footplate Extension for Transfer Assist <i>(Electronics programmed to allow footplates to be extended with or without legrest being raised.) Only available with Powered Articulation.</i>	\$1,250.00
<input type="checkbox"/>	250IE04	–	Omit Footplate Extension for Transfers.	NC
R-net Omni2 Options  P. 30 <i>For Expandable Controls, choose all that apply.</i>			\$	
<input type="checkbox"/>	250ON14	–	R-net Omni2 Only Input Control Module and 3.5" LCD Display w/ Built-In Infrared & Bluetooth Choose Mount Below	\$1,775.00
<input type="checkbox"/>	250ON15	–	R-net Omni2 Bundled Input Control Module and 3.5" LCD Display w/ Built-In Infrared & Bluetooth Bundled Omni2 Available w/ Switch-It Input Devices	NC
Omni2 Mount <i>If used w/ Standard Joystick, it must be mounted opposite side.</i>			\$	
<input type="checkbox"/>	250DS14	E1028	Link-It with Parallel Swing-Away Omni2 Mount w/ Rear Mounted Interface, Right	\$495.00
<input type="checkbox"/>	250DS15	E1028	Link-It with Parallel Swing-Away Omni2 Mount w/ Rear Mounted Interface, Left	\$495.00

SPECIALTY INPUT DEVICES

OPTION	HCPC	DESCRIPTION	RETAIL
--------	------	-------------	--------

Hand Control Packages  P. 31 *Requires Standard Joystick Omit / Only one hand control device can be ordered.*

\$

Proportional Input Devices

<input type="checkbox"/>	250EU14	E2312	Switch-It MicroGuide	\$3,295.00
<input type="checkbox"/>	250EU15	E2312	Switch-It MicroPilot	\$3,295.00
<input type="checkbox"/>	250EU16	K0108	Switch-It TouchDrive 2	\$3,845.00
<input type="checkbox"/>	250EU17	E2328	Switch-It VersaGuide	\$1,815.00
<input type="checkbox"/>	250EU18	E2328	Switch-It VersaGuide EZ	\$2,145.00
<input type="checkbox"/>	250EU19	E2328	All Round Joystick Standard	\$1,815.00
<input type="checkbox"/>	250EU20	E2328	All Round Joystick Light	\$2,145.00

Mounting Position (Required)

<input type="checkbox"/>	250EM04	E1028	Link-It to the Backrest <i>(Not Available w/ Omit Back Cushion Type)</i>	\$950.00
<input type="checkbox"/>	250EM05	E1028	Link-It to the Fixed Joystick Mount	\$295.00
<input type="checkbox"/>	250EM06	E1028	Link-It to the Parallel Swing-Away Joystick Mount	\$495.00
<input type="checkbox"/>	250EM07	E1028	Link-It to the Midline Swing-Away	\$1,050.00
<input type="checkbox"/>	250EM08	E1028	Omit Mount	NC

Mounting Platforms (Optional) *Not available w/ Link-It to Backrest*

<input type="checkbox"/>	250MG16	E0950	SunDisk Hand Tray <i>(Only available w/ MicroSeries Joysticks)</i>	\$295.00
<input type="checkbox"/>	250MG15	E0950	Bullet Hand Tray	\$295.00

Mounting Location (Required)

<input type="checkbox"/>	250IM09	–	Right	NC
<input type="checkbox"/>	250IM10	–	Left	NC

Switch Options

<input type="checkbox"/>	–	–	See Switch Selections <i>(Maximum 2)</i>	–
--------------------------	---	---	--	---

SPECIALTY INPUT DEVICES

OPTION	HCPC	DESCRIPTION	RETAIL
--------	------	-------------	--------

Head Control Packages  P. 30 *(Select headrest mount on next page)*

\$

Only one head control device can be ordered.

Proportional Input Devices

<input type="checkbox"/>	250EU25	E2328	Switch-It DualPro® Proportional Head Array - Facial Pads	\$5,715.00
<input type="checkbox"/>	250EU44	E2328	Switch-It DualPro® Proportional Head Array - Facial Pads - Dedicated Mode Outer Left	\$5,995.00
<input type="checkbox"/>	250EU45	E2328	Switch-It DualPro® Proportional Head Array - Facial Pads - Dedicated Mode Outer Right	\$5,995.00
<input type="checkbox"/>	250EU46	E2328	Switch-It DualPro® Proportional Head Array - Facial Pads - Dedicated Mode & Reverse	\$6,195.00
<input type="checkbox"/>	250EU26	E2328	Switch-It DualPro® Proportional Head Array - Spot Pads	\$5,715.00
<input type="checkbox"/>	250EU27	E2328	Switch-It RIM Proportional Head Control	\$5,895.00

Switched Input Devices

<input type="checkbox"/>	250EU28	E2330	Switch-It 3-Switch Head Array - Short Curved Wings	\$4,395.00
<input type="checkbox"/>	250EU29	E2330	Switch-It 3-Switch Head Array - Short Straight Wings	\$4,395.00
<input type="checkbox"/>	250EU30	E2330	Switch-It 3-Switch Head Array - Long Curved Wings	\$4,395.00
<input type="checkbox"/>	250EU31	E2330	Switch-It 3-Switch Head Array - Long Straight Wings	\$4,395.00
<input type="checkbox"/>	250EU42	E2330	Switch-It 4-Switch Head Array - Long Straight Wings Only - Mode Outer Left	\$4,595.00
<input type="checkbox"/>	250EU43	E2330	Switch-It 4-Switch Head Array - Long Straight Wings Only - Mode Outer Right	\$4,595.00
<input type="checkbox"/>	250EU33	E2330	Switch-It 5-Switch Head Array - Long Straight Wings Only - Mode Outer Left	\$4,725.00
<input type="checkbox"/>	250EU47	E2330	Switch-It 5-Switch Head Array - Long Straight Wings Only - Mode Outer Right	\$4,725.00

Switch Options

<input type="checkbox"/>	–	–	See Switch Selections <i>(Maximum 2)</i>	–
--------------------------	---	---	--	---

Sip 'N Puff

\$

<input type="checkbox"/>	250ID73	E2330	Switch-It Sip 'N Puff Combo Head Array with Link-It Hardware <i>(Requires headrest mount)</i>	\$4,995.00
<input type="checkbox"/>	250ID74	K0108	Switch-It OptiStop with Sip 'N Puff	\$1,945.00

Headrest Mounts *(Applies to Head/Sip 'N Puff control packages)*

\$

<input type="checkbox"/>	250IJ13	E1028	Whitmyer® Linx Headrest Mount w/ Quick Release	\$165.00
<input type="checkbox"/>	250IJ14	E1028	Whitmyer® Linx-2 Headrest Mount w/ Quick Release	\$200.00
<input type="checkbox"/>	250IJ15	E1028	Whitmyer® AXYS Headrest Mount with Quick Release	\$105.00
<input type="checkbox"/>	250IJ16	E1028	Whitmyer® AXYS Offset Headrest Mount with Quick Release	\$125.00
<input type="checkbox"/>	250IJ17	E1028	Whitmyer® Cobra FB Headrest Mount with Quick Release	\$300.00

SPECIALTY INPUT DEVICES

OPTION	HCPC	DESCRIPTION	RETAIL
--------	------	-------------	--------

Chin Control Packages P. 31

\$

Proportional Input Devices

<input type="checkbox"/>	250EU34	E2312	Switch-It MicroGuide <i>(Switches mounted to the headrest only.)</i>	\$3,295.00
<input type="checkbox"/>	250EU35	E2312	Switch-It MicroPilot <i>(Switches mounted to the headrest only.)</i>	\$3,295.00
<input type="checkbox"/>	250EU36	E2328	Switch-It VersaGuide	\$1,815.00
<input type="checkbox"/>	250EU37	E2328	Switch-It VersaGuide EZ	\$2,145.00
<input type="checkbox"/>	250EU38	E2328	All Round Joystick Light - Omni2 <i>(Requires satellite twister switches.)</i>	\$1,815.00
<input type="checkbox"/>	250EU39	E2328	All Round Joystick Standard - Omni2 <i>(Requires satellite twister switches.)</i>	\$2,145.00

Mounting Position

<input type="checkbox"/>	250EM09	E1028	Link-It To Chin Harness, Small (150mm / 6")	\$1,250.00
<input type="checkbox"/>	250EM10	E1028	Link-It To Chin Harness, Large (220mm / 8")	\$1,250.00
<input type="checkbox"/>	250EM11	E1028	Link-It To Headrest (Swing-Away)	\$1,250.00
<input type="checkbox"/>	250EM53	E1028	Link-It To Manual Chin Boom - Right Side	\$3,795.00
<input type="checkbox"/>	250EM54	E1028	Link-It To Manual Chin Boom - Left Side	\$3,795.00
<input type="checkbox"/>	250EM55	E1028	Link-It To Power Chin Boom - Right Side	\$6,495.00
<input type="checkbox"/>	250EM56	E1028	Link-It To Power Chin Boom - Left Side	\$6,495.00
<input type="checkbox"/>	250EM16	E1028	Omit Mount	NC

Input Device Mounting Location

<input type="checkbox"/>	250IM13	–	Right	NC
<input type="checkbox"/>	250IM14	–	Left	NC

Switch Options

<input type="checkbox"/>	–	–	See Switch Selections <i>(Minimum 1 for the Power Chin Boom, Maximum 3)</i>	–
--------------------------	---	---	---	---

Safety Devices

\$

<input type="checkbox"/>	250SA06	–	Switch-It Remote Stop Switch - XLR Connector	\$935.00
--------------------------	---------	---	--	----------

Switched Driving Packages

\$

<input type="checkbox"/>	250SW44	E2328	Switch-It™ Cool Cube with DB9 connector for proximity/proportional switch driving. <i>(Pro Spot proportional switches are required if proportional driving is desired.) (For non-proportional driving, single switches can be used.)</i>	\$3,470.00
--------------------------	---------	-------	---	------------

SPECIALTY INPUT DEVICES

OPTION	HCPC	DESCRIPTION	RETAIL
--------	------	-------------	--------

Switches P. 30

Single switches can be programmed to activate any function of the wheelchair including: On/Off, Mode, Profile, Speeds, Seating, Memory Positions, Horn, Lights & Indicators, IR functions, Bluetooth mouse clicks, Environmental Controls when plugged into assignable port.

Switches can connect via: Joysticks (Standard, Micro series, Versa series, All-round series) Omni2, SJX6 Hub, head controls

Switch ordering instructions:

1. Select switch type and quantity in Section "A" using columns below. (Max 6 switches. See limitations below.)
2. Select switch mounting position from Section "B" using corresponding switch column.
3. Select switch mounting location from Section "C" using corresponding switch column.

Section A – Switch Selections

Switch / Quantity

Single Function Switches - Mechanical Switches	Switch 1	Switch 2	Switch 3	Switch 4	Switch 5	Switch 6	\$
Buddy Button - Black	<input type="checkbox"/>	<input type="checkbox"/>	<input type="checkbox"/>	<input type="checkbox"/>	<input type="checkbox"/>	<input type="checkbox"/>	\$195.00
Buddy Button - Blue	<input type="checkbox"/>	<input type="checkbox"/>	<input type="checkbox"/>	<input type="checkbox"/>	<input type="checkbox"/>	<input type="checkbox"/>	\$195.00
Buddy Button - Green	<input type="checkbox"/>	<input type="checkbox"/>	<input type="checkbox"/>	<input type="checkbox"/>	<input type="checkbox"/>	<input type="checkbox"/>	\$195.00
Buddy Button - Red	<input type="checkbox"/>	<input type="checkbox"/>	<input type="checkbox"/>	<input type="checkbox"/>	<input type="checkbox"/>	<input type="checkbox"/>	\$195.00
Buddy Button - Yellow	<input type="checkbox"/>	<input type="checkbox"/>	<input type="checkbox"/>	<input type="checkbox"/>	<input type="checkbox"/>	<input type="checkbox"/>	\$195.00
Egg Switch - Black	<input type="checkbox"/>	<input type="checkbox"/>	<input type="checkbox"/>	<input type="checkbox"/>	<input type="checkbox"/>	<input type="checkbox"/>	\$110.00
Egg Switch - Blue	<input type="checkbox"/>	<input type="checkbox"/>	<input type="checkbox"/>	<input type="checkbox"/>	<input type="checkbox"/>	<input type="checkbox"/>	\$110.00
Egg Switch - Green	<input type="checkbox"/>	<input type="checkbox"/>	<input type="checkbox"/>	<input type="checkbox"/>	<input type="checkbox"/>	<input type="checkbox"/>	\$110.00
Egg Switch - Red	<input type="checkbox"/>	<input type="checkbox"/>	<input type="checkbox"/>	<input type="checkbox"/>	<input type="checkbox"/>	<input type="checkbox"/>	\$110.00
Egg Switch - Yellow	<input type="checkbox"/>	<input type="checkbox"/>	<input type="checkbox"/>	<input type="checkbox"/>	<input type="checkbox"/>	<input type="checkbox"/>	\$110.00
MicroLite <i>(Includes color labels)</i>	<input type="checkbox"/>	<input type="checkbox"/>	<input type="checkbox"/>	<input type="checkbox"/>	<input type="checkbox"/>	<input type="checkbox"/>	\$165.00
Mini Button 1 - Blue <i>(Velcro)</i>	<input type="checkbox"/>	<input type="checkbox"/>	<input type="checkbox"/>	<input type="checkbox"/>	<input type="checkbox"/>	<input type="checkbox"/>	\$105.00
Mini Button 1 - Green <i>(Velcro)</i>	<input type="checkbox"/>	<input type="checkbox"/>	<input type="checkbox"/>	<input type="checkbox"/>	<input type="checkbox"/>	<input type="checkbox"/>	\$105.00
Mini Button 1 - Red <i>(Velcro)</i>	<input type="checkbox"/>	<input type="checkbox"/>	<input type="checkbox"/>	<input type="checkbox"/>	<input type="checkbox"/>	<input type="checkbox"/>	\$105.00
Piko - Black	<input type="checkbox"/>	<input type="checkbox"/>	<input type="checkbox"/>	<input type="checkbox"/>	<input type="checkbox"/>	<input type="checkbox"/>	\$275.00
Piko - Blue	<input type="checkbox"/>	<input type="checkbox"/>	<input type="checkbox"/>	<input type="checkbox"/>	<input type="checkbox"/>	<input type="checkbox"/>	\$275.00
Piko - Green	<input type="checkbox"/>	<input type="checkbox"/>	<input type="checkbox"/>	<input type="checkbox"/>	<input type="checkbox"/>	<input type="checkbox"/>	\$275.00
Piko - Orange	<input type="checkbox"/>	<input type="checkbox"/>	<input type="checkbox"/>	<input type="checkbox"/>	<input type="checkbox"/>	<input type="checkbox"/>	\$275.00
Piko - Red	<input type="checkbox"/>	<input type="checkbox"/>	<input type="checkbox"/>	<input type="checkbox"/>	<input type="checkbox"/>	<input type="checkbox"/>	\$275.00
Piko - Yellow	<input type="checkbox"/>	<input type="checkbox"/>	<input type="checkbox"/>	<input type="checkbox"/>	<input type="checkbox"/>	<input type="checkbox"/>	\$275.00
Twister Switch - Black <i>(Must choose mount and location)</i>	<input type="checkbox"/>	<input type="checkbox"/>	<input type="checkbox"/>	<input type="checkbox"/>	<input type="checkbox"/>	<input type="checkbox"/>	\$175.00
Twister Switch - Green <i>(Must choose mount and location)</i>	<input type="checkbox"/>	<input type="checkbox"/>	<input type="checkbox"/>	<input type="checkbox"/>	<input type="checkbox"/>	<input type="checkbox"/>	\$175.00
Twister Switch - Red <i>(Must choose mount and location)</i>	<input type="checkbox"/>	<input type="checkbox"/>	<input type="checkbox"/>	<input type="checkbox"/>	<input type="checkbox"/>	<input type="checkbox"/>	\$175.00
Electronic Switches							
Flex Switch (Headrest mount only)	<input type="checkbox"/>	<input type="checkbox"/>	<input type="checkbox"/>	<input type="checkbox"/>	<input type="checkbox"/>	<input type="checkbox"/>	\$215.00
Zero Touch Proximity Sensor	<input type="checkbox"/>	<input type="checkbox"/>	<input type="checkbox"/>	<input type="checkbox"/>	<input type="checkbox"/>	<input type="checkbox"/>	\$195.00
ProSpot - Proportional Switches							
ProSpot Proportional Switch - Red	<input type="checkbox"/>	<input type="checkbox"/>	<input type="checkbox"/>	<input type="checkbox"/>	<input type="checkbox"/>	<input type="checkbox"/>	\$475.00
ProSpot Proportional Switch - Green	<input type="checkbox"/>	<input type="checkbox"/>	<input type="checkbox"/>	<input type="checkbox"/>	<input type="checkbox"/>	<input type="checkbox"/>	\$475.00
ProSpot Proportional Switch - Blue	<input type="checkbox"/>	<input type="checkbox"/>	<input type="checkbox"/>	<input type="checkbox"/>	<input type="checkbox"/>	<input type="checkbox"/>	\$475.00
ProSpot Proportional Switch - Yellow	<input type="checkbox"/>	<input type="checkbox"/>	<input type="checkbox"/>	<input type="checkbox"/>	<input type="checkbox"/>	<input type="checkbox"/>	\$475.00
ProSpot Proportional Switch - Orange	<input type="checkbox"/>	<input type="checkbox"/>	<input type="checkbox"/>	<input type="checkbox"/>	<input type="checkbox"/>	<input type="checkbox"/>	\$475.00
Section B – Switch Mounting Position							
Link-It to the Backrest <i>(Up to 1 per side)</i>	<input type="checkbox"/>	<input type="checkbox"/>	<input type="checkbox"/>	<input type="checkbox"/>	<input type="checkbox"/>	<input type="checkbox"/>	\$650.00
Link-It to the Headrest - Gooseneck & Rigid <i>(Up to 2 per side)</i>	<input type="checkbox"/>	<input type="checkbox"/>	<input type="checkbox"/>	<input type="checkbox"/>	<input type="checkbox"/>	<input type="checkbox"/>	\$650.00
Link-It to the Fixed Joystick Mount <i>(Up to 2 per side)</i>	<input type="checkbox"/>	<input type="checkbox"/>	<input type="checkbox"/>	<input type="checkbox"/>	<input type="checkbox"/>	<input type="checkbox"/>	\$495.00
Link-It to the Parallel Swing-Away Joystick Mount <i>(Up to 2 per side)</i>	<input type="checkbox"/>	<input type="checkbox"/>	<input type="checkbox"/>	<input type="checkbox"/>	<input type="checkbox"/>	<input type="checkbox"/>	\$495.00
Link-It to the Seat Rail <i>(Up to 2 per side)</i> <i>(Not avail w/knee & thigh supports)</i>	<input type="checkbox"/>	<input type="checkbox"/>	<input type="checkbox"/>	<input type="checkbox"/>	<input type="checkbox"/>	<input type="checkbox"/>	\$395.00
Omit Mount <i>(includes Velcro)</i>	<input type="checkbox"/>	<input type="checkbox"/>	<input type="checkbox"/>	<input type="checkbox"/>	<input type="checkbox"/>	<input type="checkbox"/>	NC

Section C – Switch Mounting Location

Right side of chair	<input type="checkbox"/>	<input type="checkbox"/>	<input type="checkbox"/>	<input type="checkbox"/>	<input type="checkbox"/>	<input type="checkbox"/>	<input type="checkbox"/>	\$245.00
Left side of chair	<input type="checkbox"/>	<input type="checkbox"/>	<input type="checkbox"/>	<input type="checkbox"/>	<input type="checkbox"/>	<input type="checkbox"/>	<input type="checkbox"/>	\$245.00

Joystick Integrated Switches (Pair)

<input type="checkbox"/>	250J003	–	Proximity Switches on Flex Mount, Pair <i>(Used with VersaGuide/VersaGuide EZ)</i>	\$995.00
<input type="checkbox"/>	250J004	–	Satellite Twister Switches, Pair, Red and Green. <i>(With All Round Light & Standard)</i>	\$395.00

Additional Switches (Velcro)

<input type="checkbox"/>	250SA08	K0108	Mini 2 - Button <i>(Stereo Plug)</i>	\$240.00
<input type="checkbox"/>	250SA09	K0108	Mini 2 - Button <i>(Dual Mono Plug)</i>	\$240.00
<input type="checkbox"/>	250SA10	K0108	Mini 4 - Button In-Line <i>(DB9 connector)</i>	\$545.00

JAY® SYNCRA™ SEATING MEASURING GUIDE

JAY® SYNCRA™ BACK



Backrest Width	16"	18"	20"	22"
Max User Trunk Width	13.5"	15.5"	17.5"	19.5"

JAY® Swing-Away Lateral Thoracic Adjustment Range

Syncra Back Width	Width Range	Height range from bottom of shell to seat pan
16"	10" to 24"	12" to 19.5"
18"	12" to 26"	12.5" to 21.5"
20"	14" to 28"	12.5" to 22"
22"	16" to 30"	13.5" to 23"

Syncra™ Fixed Lateral Support Accessory Range

Syncra Back Width	Width Range	Height range from bottom of shell to seat pan	Contour Depth Range
16"	16.4" to 16.8"	6" to 8"	3" to 5"
18"	18.4" to 18.8"	6" to 8"	3" to 5"
20"	20.4" to 20.8"	6" to 8"	3" to 5"
22"	22.4" to 22.8"	6" to 8"	3" to 5"

Syncra™ Back Shell Height Diagram

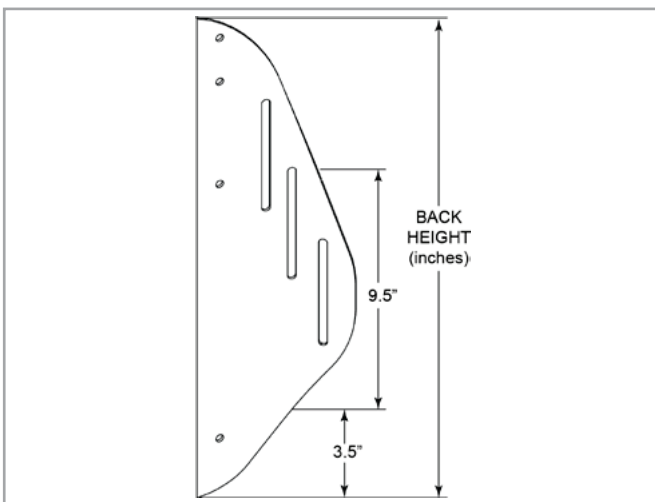

JAY® SYNCRA™ CUSHION



JAY® Lateral Thigh Support Adjustment Range

Syncra Cushion Width	Width Range
16"	8.5" to 16.0"
17"	9.5" to 17.0"
18"	10.5" to 18.0"
19"	11.5" to 19.0"
20"	12.5" to 20.0"
22"	14.5" to 22.0"

POWER BASE

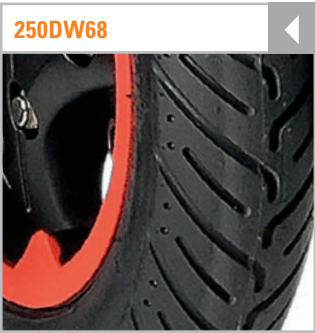

14" Drive Wheel, Pneumatic, V-Type

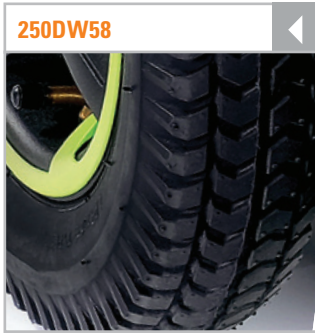

14" Drive Wheel, Knobby



6" Caster Wheels

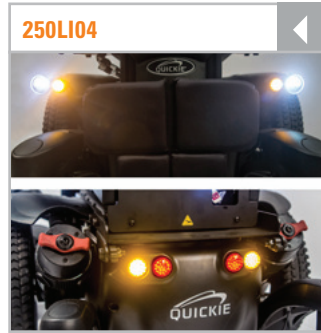

LED Lights



Charger

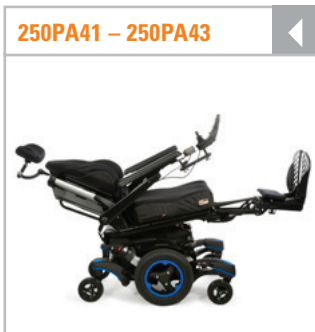

Power Seating: Tilt, Recline

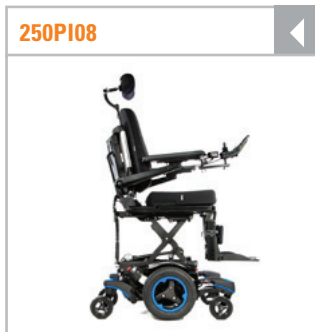

Power Seating: Elevate

SEATING AND POSITIONING



JAY® J3® Back: 2.2"



JAY® J3® Back: 3"



JAY® J3® Back: 6"



JAY® Anterior Thoracic Support



JAY® J3® Back, Spine-Align Kit 2



SEDEO® Cushion

SEATING AND POSITIONING

250CU59 – 250CU60



JAY® Ion® Cushion

250CU61 – 250CU62



JAY® Union® Cushion

250CU66 – 250CU69



JAY® Fusion® Cushion w/Air

250CU64 – 250CU65



JAY® Fusion® Cushion w/Fluid

250CU55



JAY® X2® Cushion

250CU56



JAY® J2® Cushion

250CU57 – 250CU58



JAY® J2® Deep Contour Cushion

250EG35



SEDEO® PRO™ Reclining Flip Back Armrest

250EG33



SEDEO® PRO™ Single Post Removable Armrest

250AB47



Comfort Reclining Armpad, Foam

250AB43



SEDEO® Reclining Armrest Pad

250AB48



Comfort Reclining Armpad, Gel

250H109



Power Centermount Legrest, Power Articulation

250H175

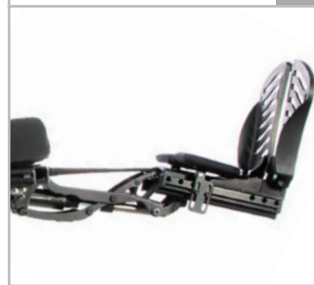

Power Centermount Legrest, Mechanical Articulation

SEATING AND POSITIONING

250A837 – 250A840

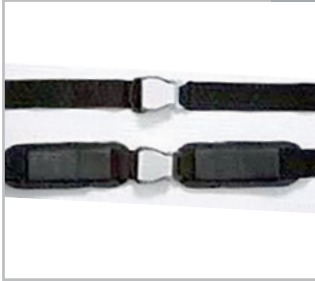

Positioning Belt, Aircraft Style

250HE36



SEDEO® Headrest, Small

250HE37



SEDEO® Headrest, Flexible

250MH32



SEDEO® Multiposition Headrest Mount

250HE38 – 250HE44



Whitmyer® Plush Headrest

250HE45 – 250HE47



Whitmyer® Adjust-a-Plush Headrest

250MH33



Whitmyer® Linx Headrest Mount

250MH34



Whitmyer® Linx-2 Headrest Mount

ELECTRONICS

250J116



R-net Color LCD (CJSM1)

250J117



R-net Color LCD, Heavy Duty

250J118



R-net High Resolution Color LCD (CJSM2+BT)

250JH16



Goalpost Joystick Handle

250JH15



T-Handle Joystick Handle

250JH14

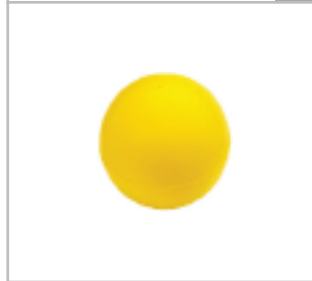

Foam Ball Joystick Handle

250JH13



Ball Joystick Handle

ELECTRONICS

250PR10



R-net PC Programmer

250ER10



R-net Power Module

2500A05



Attendant Control

250EY22



Ctrl+5®, Push Button

250EY23



Ctrl+5®, Toggle

2500N14



R-net Omni2

250EU28 – 250EU31



Switch-It™ Head Array

250EU25 – 250EU26



Switch-It™ Dual Pro® Proportional Head Array

250EU27



Switch-It™ RIM Proportional Head Control

ELECTRONICS

250EU14 & 250EU34



Switch-It™ MicroGuide

250EU15 & 250EU35



Switch-It™ MicroPilot

250EU17 & 250EU36



Switch-It™ VersaGuide

250EU16



Switch-It™ TouchDrive 2 (TD2)

250EU20



All Round Joystick, Light

250EU19



All Round Joystick, Standard

250EM04



Link-It to Backrest

250EM05

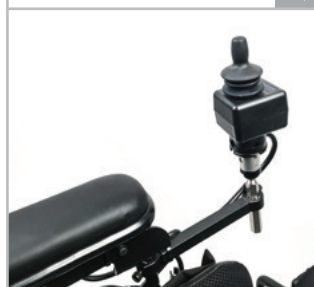

Link-It to Fixed Joystick Mount

250EM06

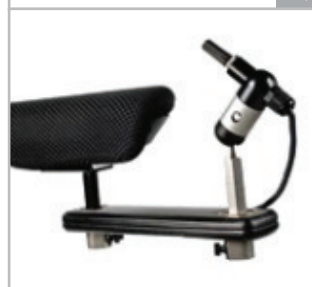

Link-It to Parallel Swing-Away Joystick Mount

250EM07

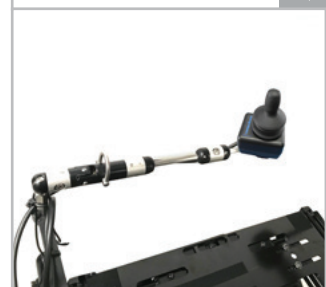

Link-It to Midline Swing-Away Joystick Mount

250EM09

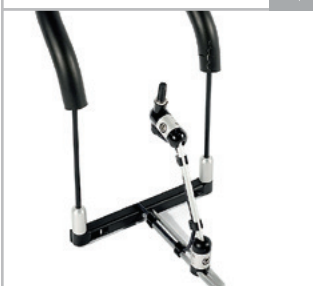

Link-It to Chin Harness

250EM11



Link-It to Headrest, Swing-Away

250EM53



Link-It to Manual Chin Boom

250EM55



Link-It to Power Chin Boom

ELECTRONICS

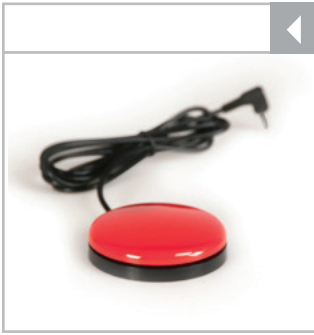

Buddy Button
black, blue, green, red, yellow

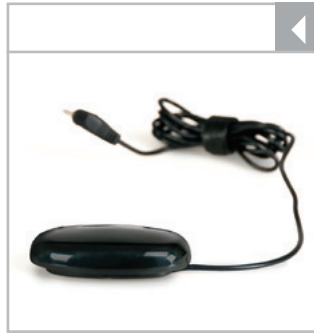

Egg Switch
black, blue, green, red, yellow



MicroLite



Piko Button
black, blue, green, orange, red,
yellow

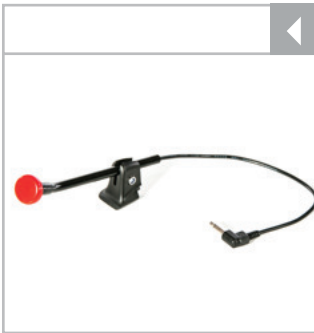

Twister Switch
black, green, red

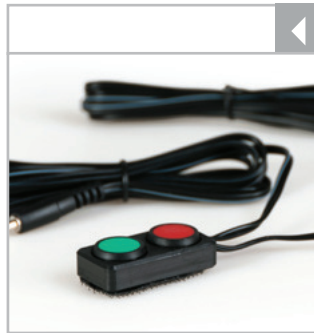

Mini 2

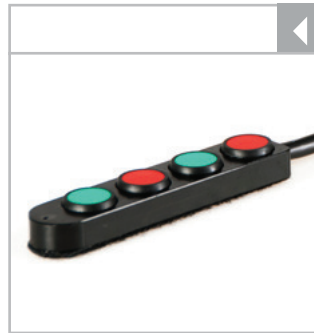

Mini 4



Mini 1 Button (Mono Plug)
blue, green, red



Q700 M with SEDEO® PRO™

\$

Base Price	<input type="text"/>
Total of additional equipment	<input type="text"/>
Packaging and transport	<input type="text"/>
Total Price	<input type="text"/>

Date

Signature

Month

Day

Year

Send E-Mail

