

**SUPREME.**  
More than design



[www.qmdrain.com](http://www.qmdrain.com)





# **SUPREME** HAS SET A NEW BENCHMARK IN SHOWER DRAINS

**SUPREME** revolutionizes  
the installation of linear drains

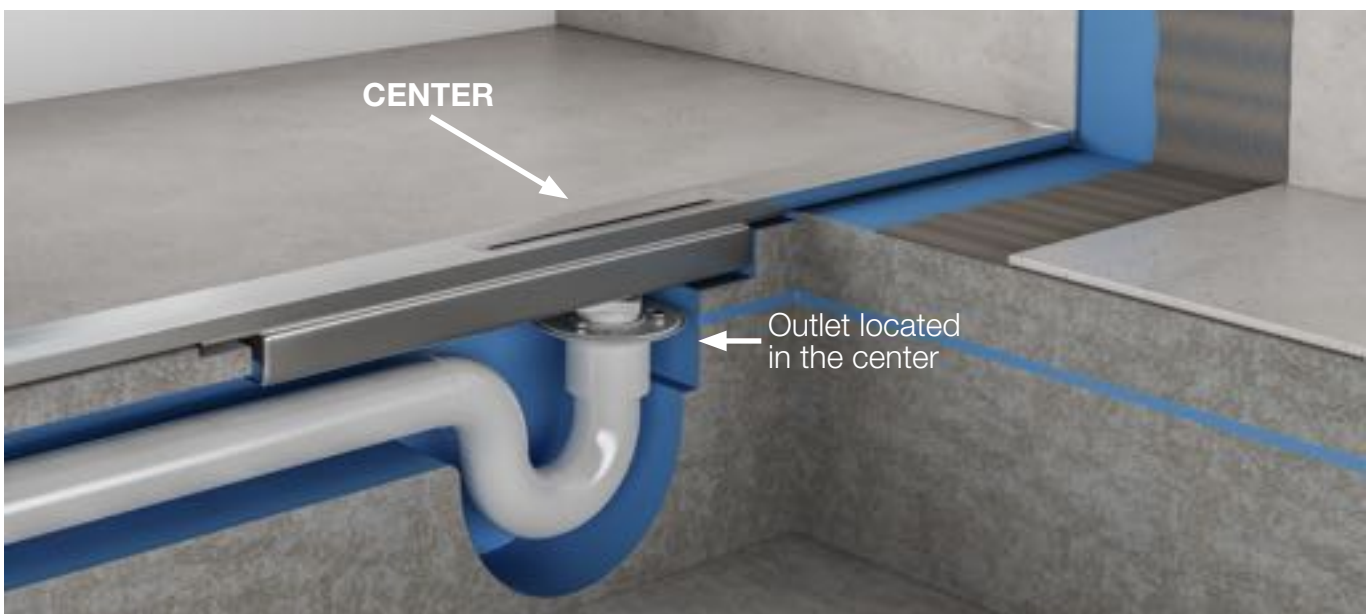
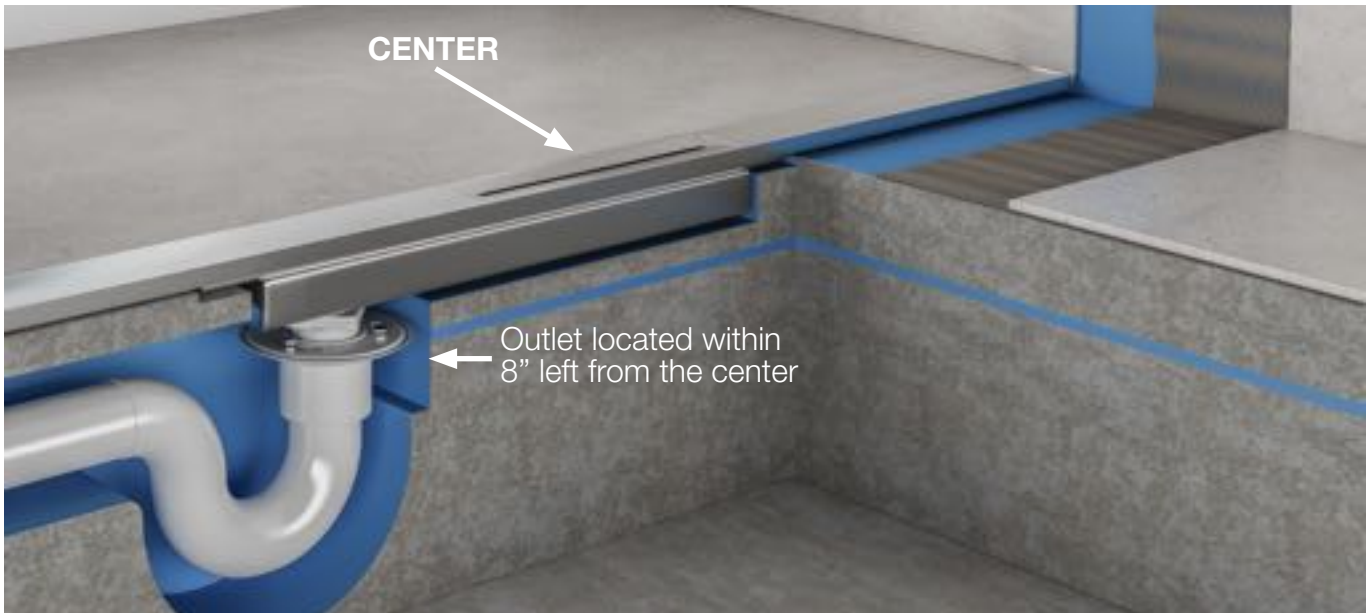



**SUPREME.**  
More than design

### VERSATILITY & FLEXIBILITY

**SUPREME** is a unique linear shower drain that solves one of the biggest problems facing installers and plumbers in both construction and remodeling, eliminating the need to relocate existing plumbing when the water outlet is located a few inches off-center.

This awarded and innovative product offers an independent base that houses an internal rail system which enables the grate to be in a different position than the base and the outlet, allowing a quick and easy installation. Its superior design provides a flexible 8-inch range from the center of the shower, allowing you to center your drain without moving the existing pipe.



**Removable grate** allows access to the base.

**Grate** can be cut to a specific length.

**Drain base** has an offset 2" outlet. This feature allows you to rotate the base to accommodate a left or right position and the sliders adjust to connect the grate in a different position than the outlet.





One drain channel...  
four grates sizes, four finishes, all the possibilities.









## Delmar Series

# SUPREME.

Inspired by the wild imagination of the seas



### Accessories included



Hair Strainer



Key



Threaded Nipple



Stainless Steel Blade



Level



Sikaflex



Wedges

### Finishes



Satin



Polished



Satin Gold



ORB/ Black

**Material** Stainless Steel Marine 316.  
Install with standard waterproofing methods.

### Supreme Kit SKU

	Satin	Polished	Gold	ORB/Black
Length 30"	33.800.30	33.800.30 P	33.800.30 G	33.800.30 ORB
40"	33.800.40	33.800.40 P	33.800.40 G	33.800.40 ORB
50"	33.800.50	33.800.50 P	33.800.50 G	33.800.50 ORB
60"	33.800.60	33.800.60 P	33.800.60 G	33.800.60 ORB







## MATERIAL AND CUSTOMIZATION

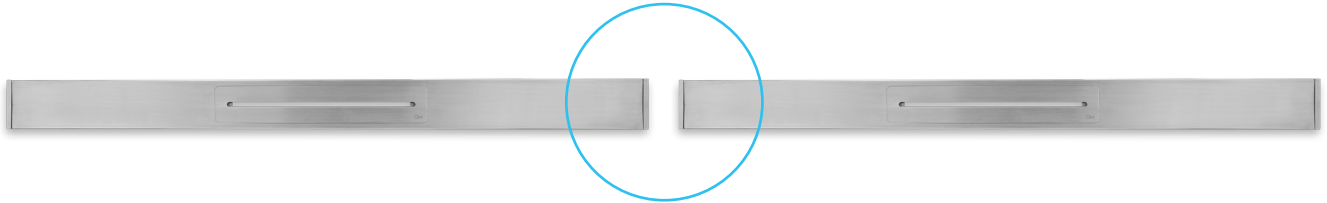

The design and flexibility of Supreme is perfect for large showers and spas. The grate can be cut to your specific length and multiple drains can be aligned to accommodate multiple outlets.



**SUPREME** is shaped using stainless steel 316. This marine grade stainless steel is the highest corrosion-resistant metal on the market. It resists extreme moisture and abrasive household cleaners, making it the best choice for your shower. Eco-friendly and 100% recyclable.

## SUGGESTED POSITION IN THE SHOWER AND SLOPE

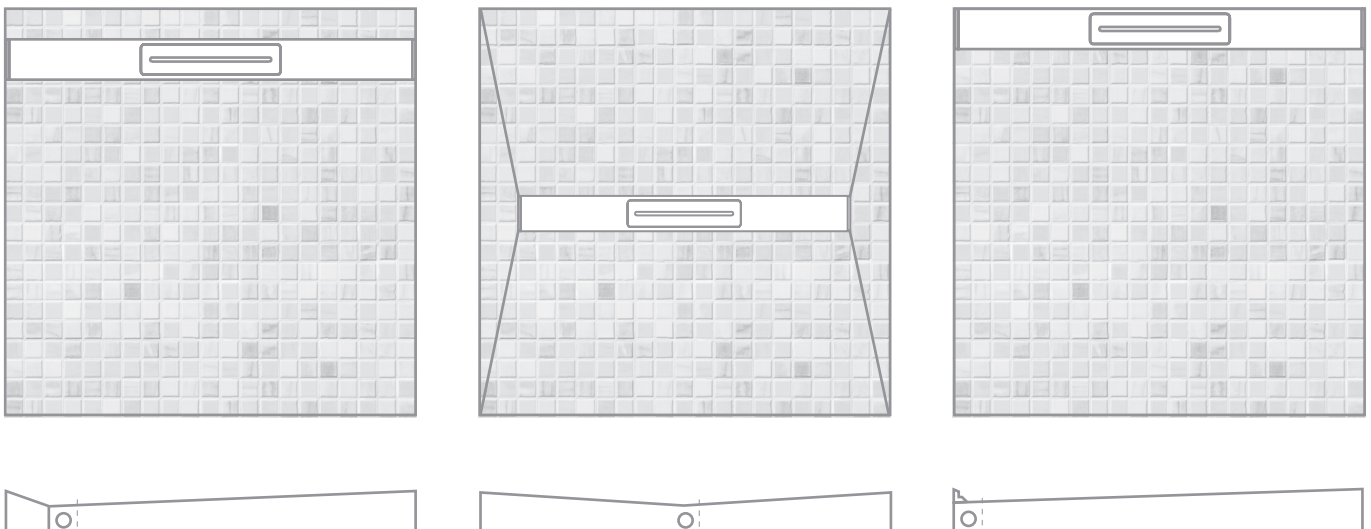





**Technical** Information  
&  
Installation **Instructions** 

**DELMAR LINEAR DRAIN SUPREME LINE**

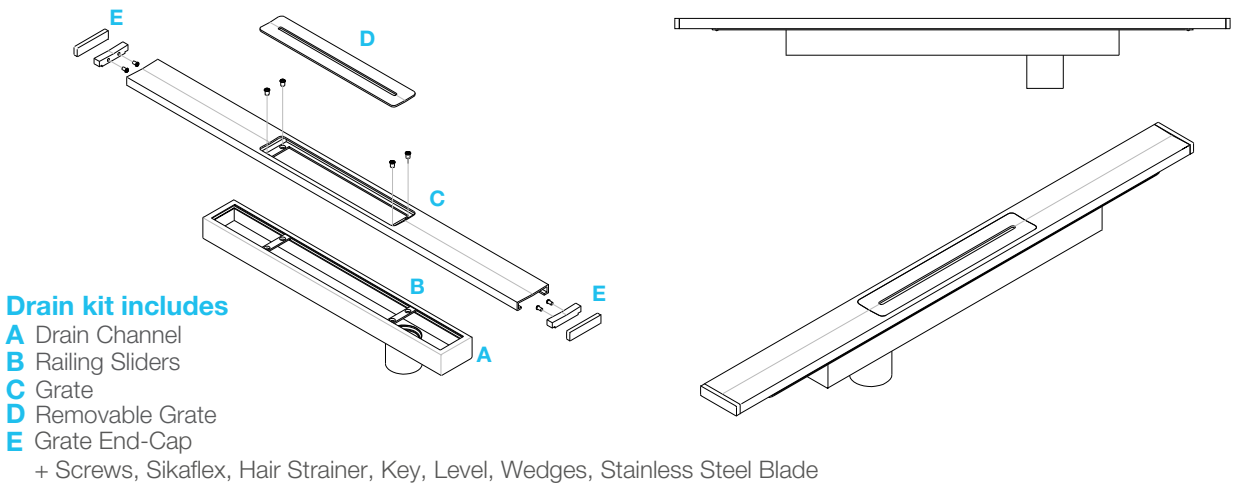

**Specifications**

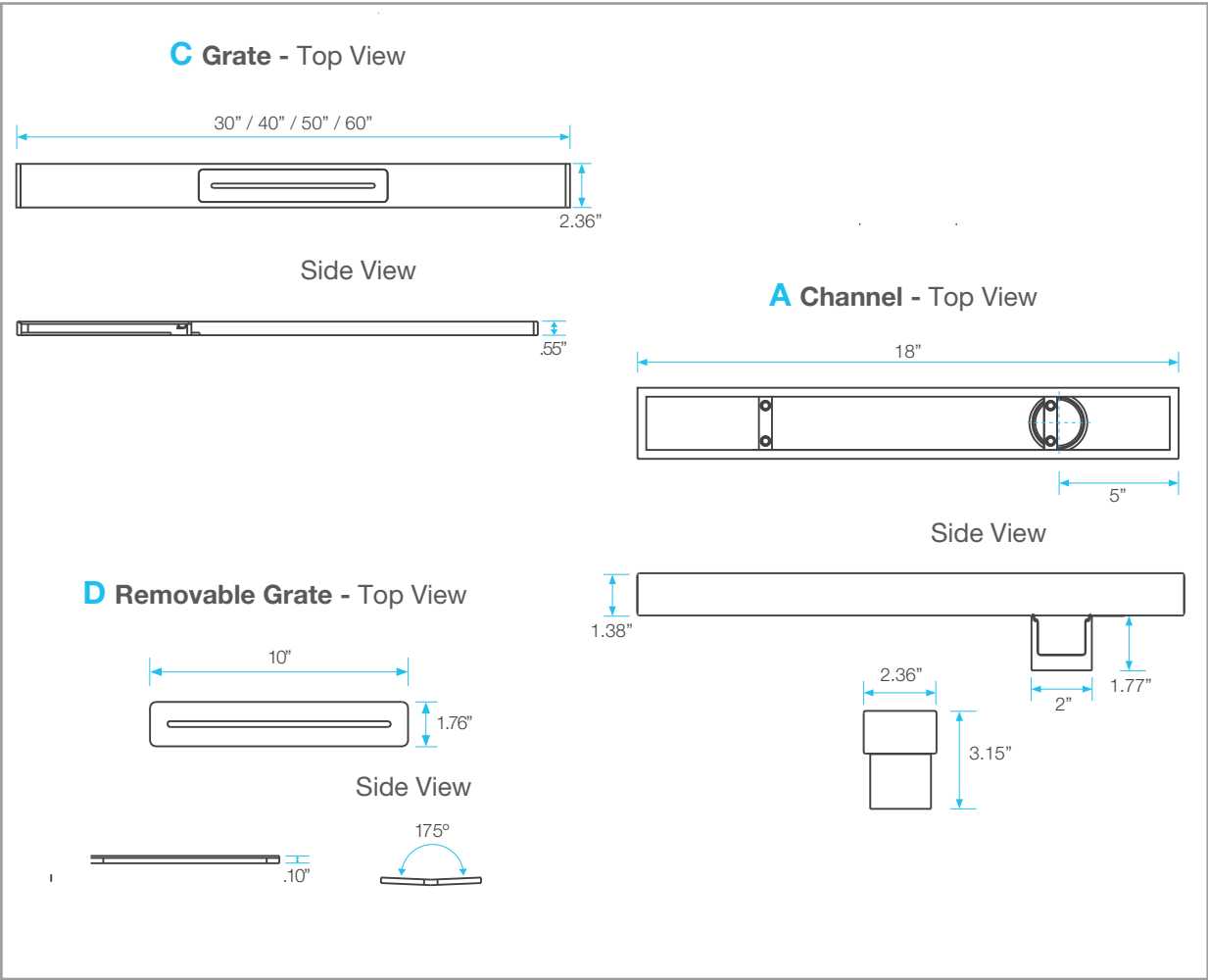







**QM USA, Corp.**  
 4100 N Powerline Road, Suite Z3  
 Pompano Beach, FL, USA 33073  
 P: 954 773 9450  
 info@qm-us.com  
[www.qmdrain.com](http://www.qmdrain.com)

**Delmar Series Features**

- 13 gauge 316 Stainless Steel Grate = 2.5 mm.
- 18 gauge 316 Stainless Steel Base = 1.2 mm.
- Works with 2" ABS, PVC or Cast Iron shower drain flange (not included).
- Standard Finishes: Satin, Polished, Satin Gold and ORB/Black.
- Hair Strainer Basket comes with every drain, fits inside the drain to collect hair and other debris, preventing pipe clogs. Optional.
- Delmar Series is intended for use with traditional waterproofing methods.

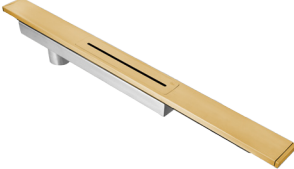
**Supreme Complete Kit**

	<b>Satin Finish</b>			<b>Satin Gold Finish</b>	
	<b>SKU</b>	<b>Length</b>		<b>SKU</b>	<b>Length</b>
	33.800.30	30"		33.800.30 G	30"
	33.800.40	40"		33.800.40 G	40"
	33.800.50	50"		33.800.50 G	50"
	33.800.60	60"	33.800.60 G	60"	
	<b>Polished Finish</b>			<b>ORB/Black Finish</b>	
	<b>SKU</b>	<b>Length</b>		<b>SKU</b>	<b>Length</b>
	33.800.30 P	30"		33.800.30 ORB	30"
	33.800.40 P	40"		33.800.40 ORB	40"
	33.800.50 P	50"		33.800.50 ORB	50"
	33.800.60 P	60"	33.800.60 ORB	60"	

**Kit includes**

- Drain Channel
- Railing
- Grate Cover
- Removable Grate
- Key
- Level
- Grate End-Cap
- Screws
- Sikaflex
- Hair Strainer
- Wedges
- Stainless Steel Blade

**Add to Kit**

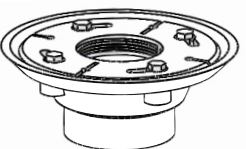
	<b>Drain Flange</b>	<b>SKU</b>
	2" PVC	83.100.00 PVC
	2" ABS	83.100.00 ABS
	2" Cast Iron No hub	83.100.01
	2" Cast Iron FIP	83.100.01F

**Note:** Installer must verify all rough-in dimensions prior to installation and consult local and national codes. Conformity and compliance to local and national codes are the responsibility of the installer. Dimensions are subject to Manufacturers tolerance and change without notice. We can assume no responsibility for use of superseded or void data.

## INSTALLATION INSTRUCTIONS

Before beginning installation make sure the distance between the center of the shower and the outlet is within 8" of each other.

 Installation video available at: <http://qmdrain.com/product-category/linear-drains/supreme/>

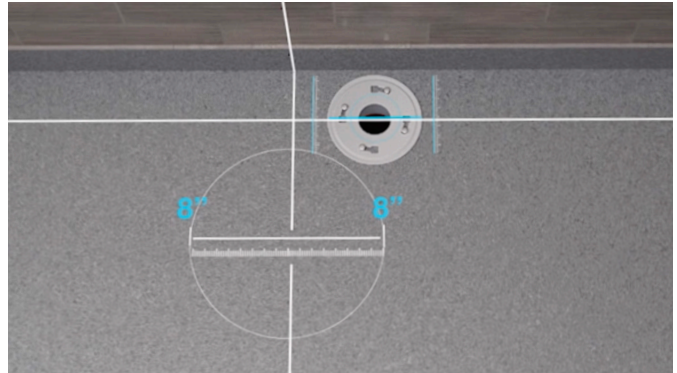

**Step 1.** Have your shower area ready, waterproofing installed and tested.

**Step 2.** Mark the center of your shower and screw threaded nipple into the drain flange, adjust to desired height.



**Step 3.** Insert the drain channel into the threaded nipple.

**Step 4.** Trowel mortar to required height.



**Note:** the longest side of the channel should always go towards the center of the shower.

**Tip:** measure the floor thickness and leave just the space for thin set and floor tile, taking into consideration the grate height. Your floor should end flush with the grate.

**Step 5.** Once mortar has cured, move the railing sliders into position, each at 4.5" from the center of the shower.

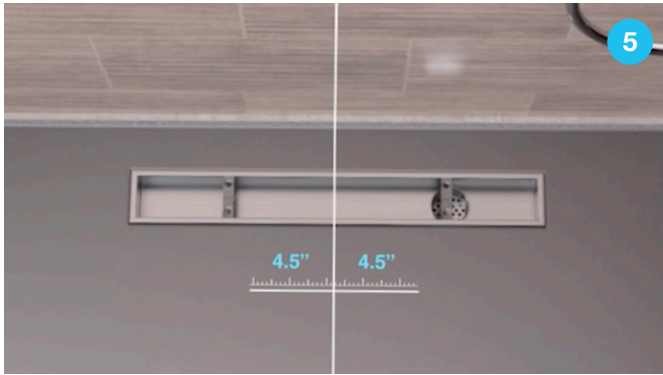

**Step 6.** Attach the grate to the channel. With the sliders positioned correctly, place the grate over the base and make sure the grate looks centered in the shower, adjust accordingly.



If grate needs to be cut to specific length, remove the grate end-caps, and cut using the enclosed stainless steel blade or a Handheld Hacksaw with 32 TPI for cleanest cut. Handheld Hacksaw is recommended for cutting all grates except the satin finish.

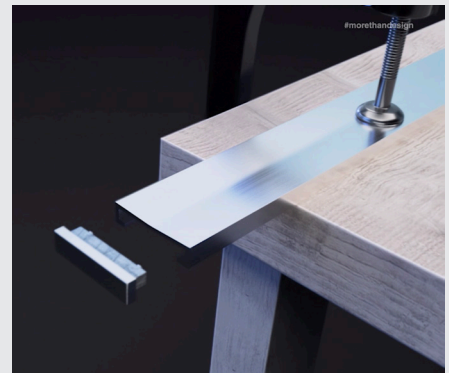
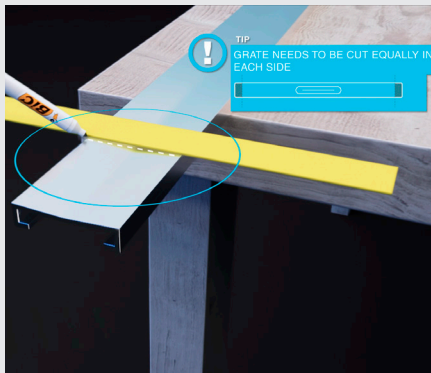

**Tips:**

- Use painter's tape on grate surface to protect finish when cutting.
- Grate needs to be cut equally on each side.
- Draw a straight line where the cut will be made.
- Clamp grate to stable surface for cutting.
- Gently file edges.
- Do not bend or pull away cut sections, allow them to fall away.
- Re-connect end-caps.

Installation video available at: <http://qmdrain.com/product-category/linear-drains/supreme/>

**6a.** Once grate and slider position are verified, apply Sikaflex around the top edge of the base and thin-set to the bottom of the grate.



**6b.** Install grate on top of the base and screw into the sliders using the enclosed screws.



**Step 7.** Verify that the grate is perfectly straight and level before installing the floor. Use enclosed wedges to raise any part of the grate if needed.



**Step 8.** Apply thin-set and install tile and grout.

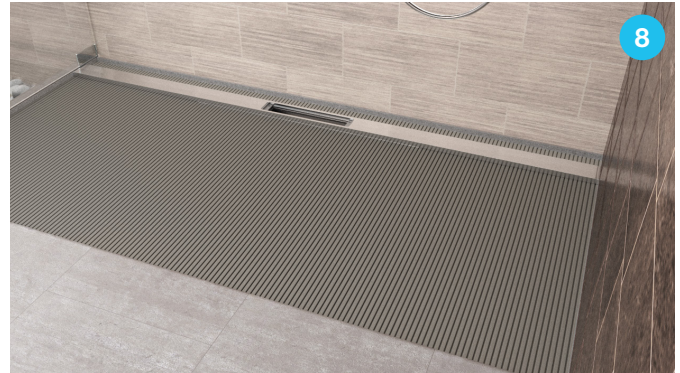

**Step 9.** Remove the stainless steel protector and place the removable grate.



**Note:**

- Waterproof membrane should be installed and tested per manufacturer's instructions and local building and plumbing codes.
- QM® recommends this product to be installed by a licensed contractor.
- Failure to achieve adequate floor slope will result in standing water problems or slow water flow. Recommended slope for a shower floor is about 4 percent, or a 1/2 inch drop per every 12 inches from the shower walls to the drain.
- QM® Drain fits into the most common 2" ABS, PVC or cast iron shower drain flange.
- Lifting key assists with grate removal.
- Hair strainer basket fits inside the drain to collect hair and other debris preventing pipe clogs. Empty basket as needed to maintain optimal performance. The use of the basket is optional.







[www.qmdrain.com](http://www.qmdrain.com)



QM USA, Corp.  
4100 N Powerline Road, Suite Z3  
Pompano Beach, FL 33073, USA.  
[info@qm-us.com](mailto:info@qm-us.com) • Phone: (954) 773 9450

  QM Drain  [qmdrain](https://www.instagram.com/qmdrain)