

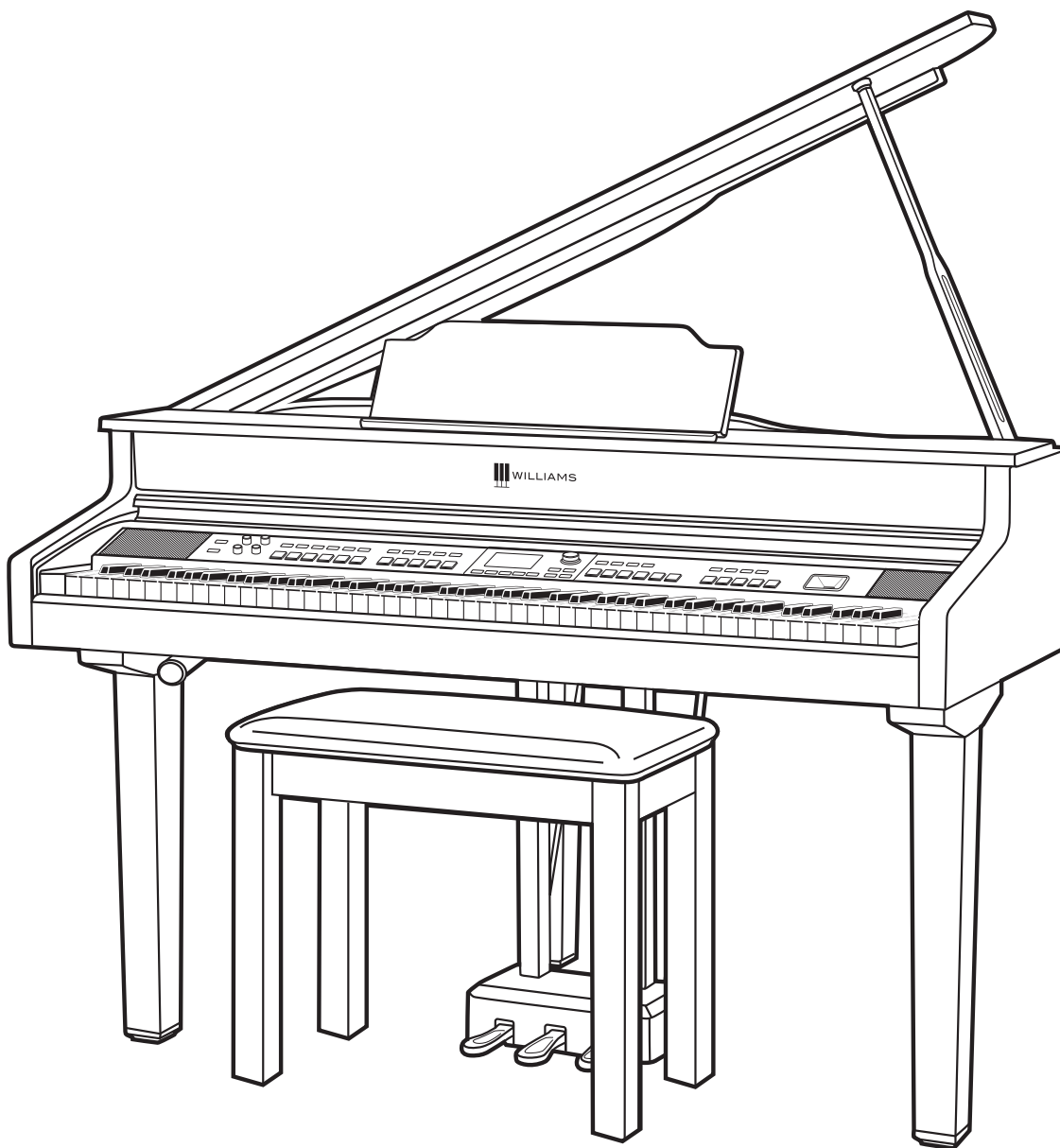

WILLIAMS®



SYMPHONY GRAND II

DIGITAL PIANO

OWNER'S MANUAL

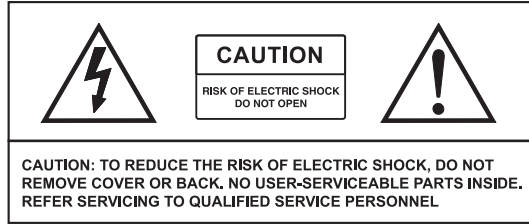

IMPORTANT SAFETY INSTRUCTIONS

- Do not use near water.
- Clean only with a soft, dry cloth.
- Do not block any ventilation openings.
- Do not place near any heat sources such as radiators, heat registers, stoves, or any other apparatus (including amplifiers) that produces heat.
- Do not remove the polarized or grounding-type plug.
- Protect the power cord from being walked on or pinched.
- Only use the included attachments/accessories.
- Unplug this apparatus during lightning storms or when unused for a long period of time.
- Refer all servicing to qualified service personnel. Servicing is required when the apparatus has been damaged in any way, such as power-supply cord or plug is damaged, liquid has been spilled or objects have fallen into the apparatus, the apparatus has been exposed to rain or moisture, does not operate normally, or has been dropped.

FCC STATEMENTS

1. Caution: Changes or modifications to this unit not expressly approved by the party responsible for compliance could void the user's authority to operate the equipment.
2. NOTE: This equipment has been tested and found to comply with a Class B digital device, pursuant to Part 15 of the FCC Rules. These limits are designed to provide reasonable protection against harmful interference in a residential installation. This equipment generates, uses, and can radiate radio frequency energy and, if not installed and used in accordance with the instructions, may cause harmful interference to radio communications. However, there is no guarantee that interference will not occur in a particular installation. If this equipment does cause harmful interference to radio or television reception, which can be determined by turning the equipment off and on, the user is encouraged to try to correct the interference by one or more of the following measures:
 - Reorient or relocate the receiving antenna.
 - Increase the separation between the equipment and receiver.
 - Connect the equipment into an outlet on a circuit different from that to which the receiver is connected.
 - Consult the dealer or an experienced radio/TV technician for help.

WARRANTY

Williams provides the following limited warranty, to the original purchaser: this piano is warranted to be free from electronic and/or structural defects in materials and workmanship for a period of one (1) year from the date of original purchase. If this Williams piano is defective, at its option during the warranty period, subject to the terms of this limited warranty and upon proof of purchase, Williams will either repair or replace the listed piano with a same or similar model of equal age or newer. Any repairs or modifications must be completed by Williams and/or an authorized agent of Williams. The warranty obligations as set forth herein shall be performed free of charge with the exception of all delivery and shipping expenses. This limited warranty will not apply to this product in the case of misuse, abuse, neglect, alterations, normal wear and tear or other circumstances not directly attributed to electronic and/or structural defects in materials or workmanship. Without limiting the foregoing, this limited warranty will also be inapplicable to products that have not been maintained or replaced in accordance with the manufacturer's instruction, or to products from which the serial number has been removed or altered. If covered defects are found, contact your authorized Williams dealer with regard to the alleged defect within ten (10) days of discovery of the problem.

The foregoing repair or replacement obligation for defective products shall be the sole and exclusive remedy of this limited warranty. All warranties including, but not limited to, the express warranty and the implied warranties of merchantability and fitness for a particular purpose are limited to the one (1) year warranty period. Some states do not allow limitation on how long an implied warranty lasts, so the above limitation may not apply to you. There are no express warranties beyond those stated here. In the event that applicable law does not allow the limitation of the duration of the implied warranties to the warranty period, then the duration of the implied warranties shall be limited to as long as is provided by applicable law. No warranties apply after that period. Retailer and manufacturer shall not be liable for damages based upon inconvenience, loss of use of product, loss of time, interrupted operation or commercial loss or any other incidental or consequential damages including but not limited to lost profits, downtime, goodwill, damage to or replacement of equipment and/or property.

1 Year Parts & Labor Warranty

Register online at www.williams pianos.com

TABLE OF CONTENTS

IMPORTANT SAFETY INSTRUCTIONS	2	SONG TUTOR	18
INTRODUCTION	3	FUNCTIONS	18
ASSEMBLY INSTRUCTIONS	4	RESETTING TO FACTORY DEFAULT	21
TAKING CARE OF YOUR DIGITAL PIANO	8	MIDI FUNCTIONS	21
FRONT PANEL	9	BLUETOOTH FUNCTIONALITY	22
I/O PANEL AND JACKS	11	SPECIFICATIONS	23
OPERATIONS	12	VOICE LIST	23
DEMO SONGS	12	DEMO SONG LIST	27
KEY LIGHTS	12	STYLE LISTS	28
VOICE MODE	12	DRUM SOUND LISTS	29
SPLITS	14	PLAYING CHORDS IN STYLE MODE	36
LAYERS	14	FINGERED MODE CHART	38
STYLE MODE	14	MIDI IMPLEMENTATION CHART	39
SONG MODE	15	SONG TUTOR LIST	40
REGISTRATIONS	17		

INTRODUCTION

Congratulations! You have just purchased a state of the art digital piano that provides remarkable acoustic sound and feel. We recommend that you read through this owner's manual carefully, so you can get the most enjoyment from your new piano.

Features include:

- Full Color Graphic LCD display
- 256-voice polyphony
- Realistic Grand Piano recorded without loops, with unique piano effects- sustain layer, sustain pedal and key release sounds
- 172 Voices from the Williams Sound library, including a General MIDI soundset
- 180 Customized accompaniment styles from various music genres such as Rock, Funk, Jazz, Traditional, Country and more
- Lights above the keys interact with educational software to teach you piano
- Bluetooth functionality for audio and MIDI
- 4 Track Song Recorder
- USB/MIDI connections and stereo/mono line out jacks, stereo line input jacks
- USB host device jack for saving songs and loading/playing MIDI files

BEFORE YOU GET STARTED

Your piano was carefully packed at the factory, and the packaging was designed to protect the unit from rough handling.

- If the unit is damaged, call Williams Product Support: **(888) 241-1582**.
- Use the original packing carton when storing or transporting.
- Make sure children are supervised when near the piano or its packaging.

INITIAL OPERATION / QUICK START

- Plug the power cord into a 120V supply.
- Press the power button. The LED will light.
- Press the Voice Select button for the desired voice.
- Adjust the volume control.



ASSEMBLY INSTRUCTIONS

What's Included

*Not pictured:
Power cord, Headphone hook and screws,
and Owner's Manual.*

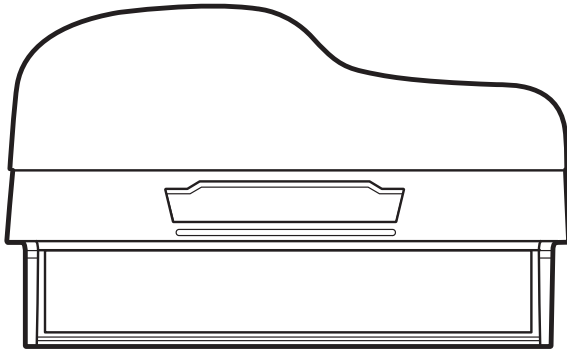

Piano Body

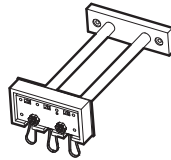

Pedal Board



Pedal Board
Support Rods x(2)

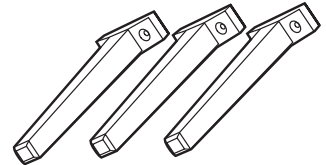

Legs x(3)

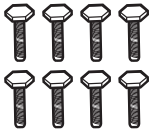

Leg and Pedal Board
Bolts x(8)

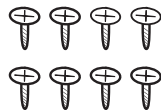

Pedal Board Support
and Screws x(8)



Adjustable
Wrench



Washers x(8)

Piano Assembly

1. Begin assembly by placing the main piano unit on its side, on a padded or carpeted surface. Be sure to place the hinged side of the lid up, as shown.

2. Leaving piano on its side, attach the top leg and the rear leg as shown.

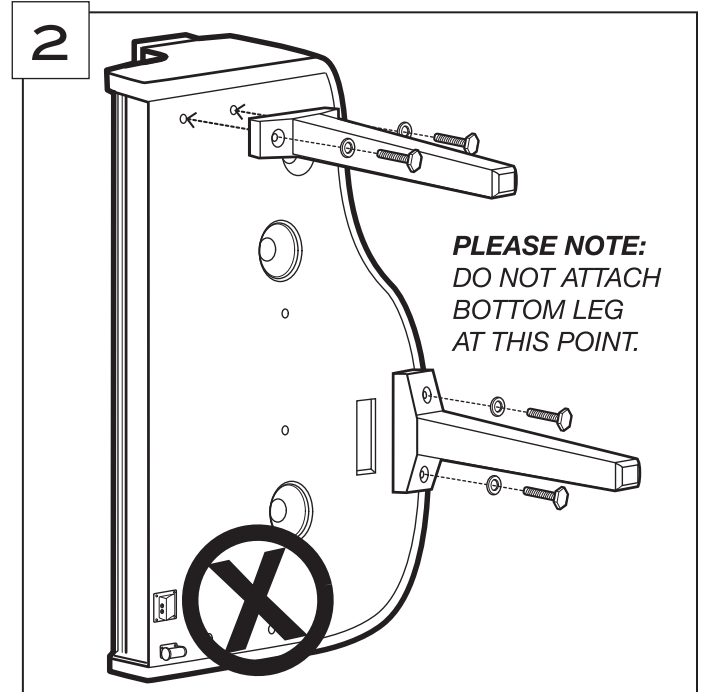

SYMPHONY GRAND II DIGITAL PIANO

3. Attach both the pedal board and the legs using the eight leg/pedalboard bolts.

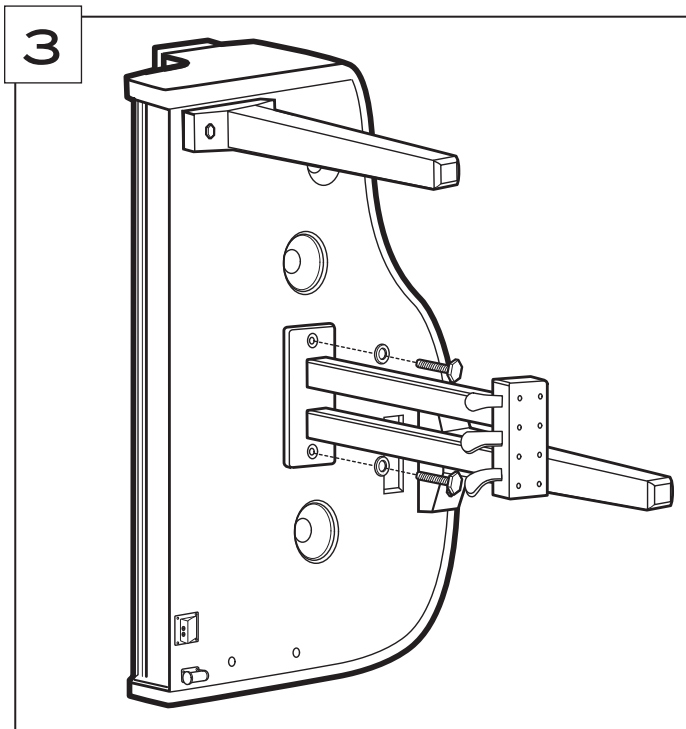

4. Attach pedal board supports to the pedal board and piano body as shown. Use two pedal board support screws to attach to the pedals first, then attach to the piano bottom second.

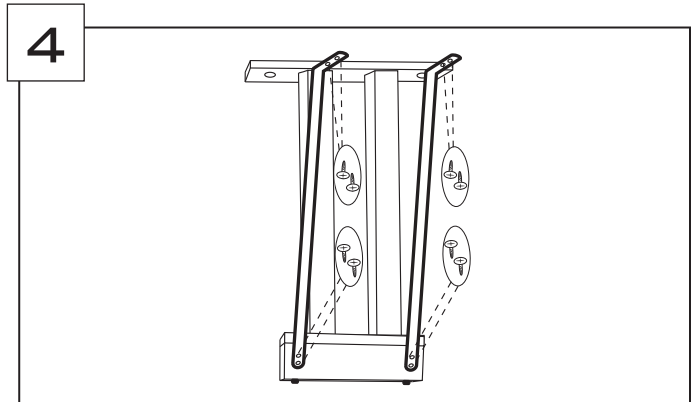

6. With the pedal board, top leg, and rear leg firmly secured, lift and rotate the piano in a tipping motion to the upright position.

Take care not to drag the rear leg or pedal board against the ground.

5. Position a pillow or thick blanket so that the pedal board assembly will rest upon it when the piano is turned upright.

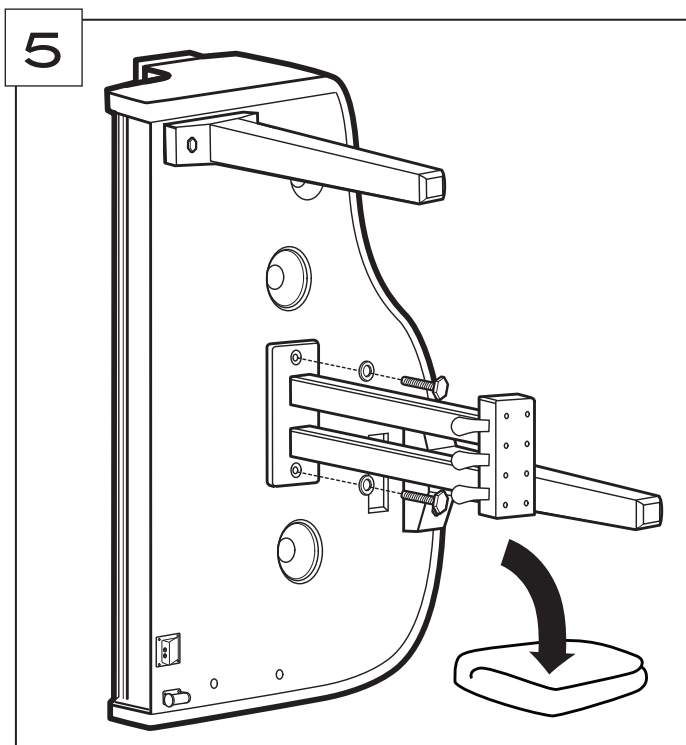

6



PLEASE NOTE:

Two or more people are needed to complete the assembly. DO NOT CONTINUE WITHOUT HELP.

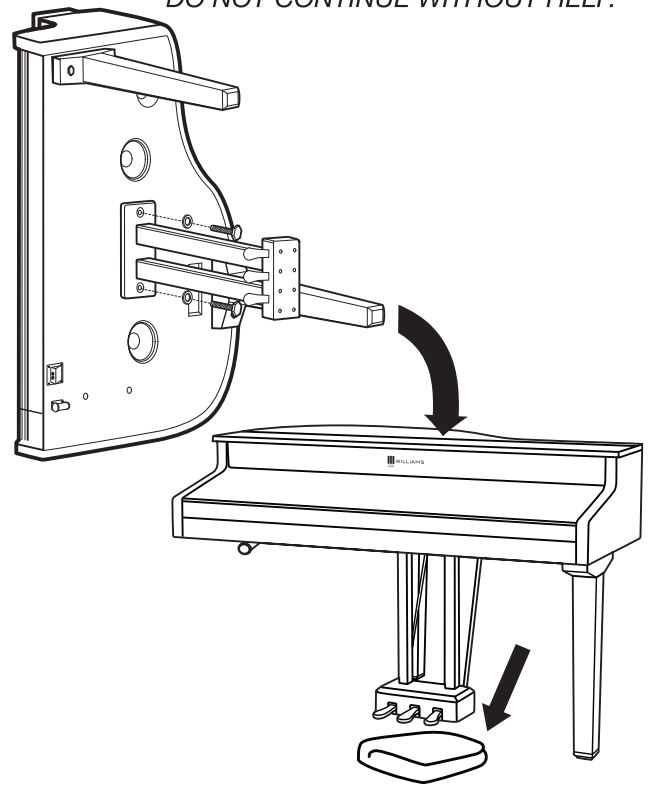

7. With 1-2 people holding the piano upright, attach the final leg as shown.

With someone lifting the front of the piano, remove the blanket or towel you used in step 4.

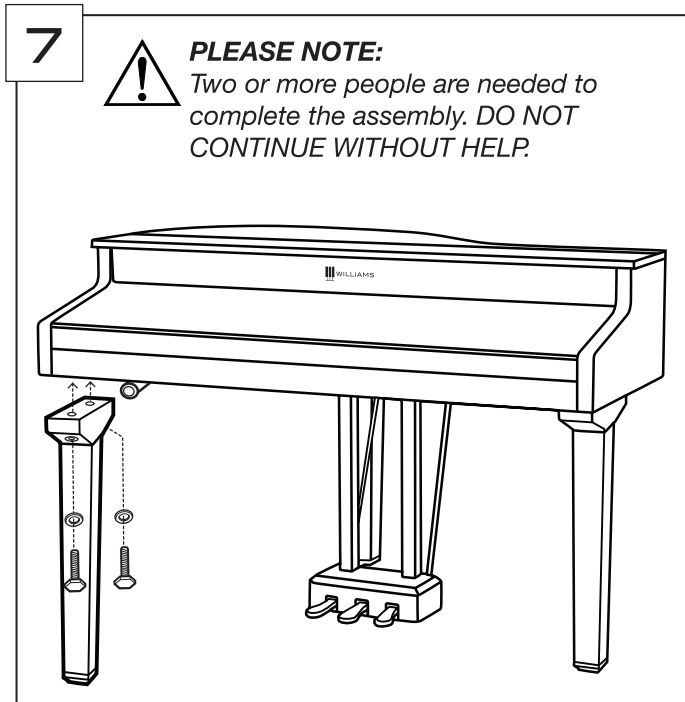

8. Attach the headphone holder to the bottom left of the piano with four machine screws.

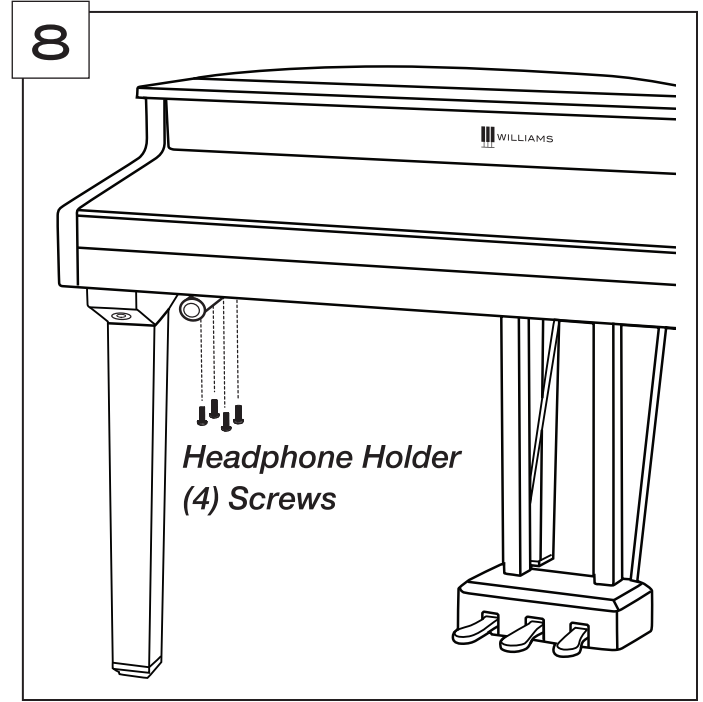

9. With the blanket or pillow removed, connect the power cable to the bottom of the piano, plug the other end into a power source.

Also locate the pedal cable attached to the pedal board. Connect it to the bottom of the piano.

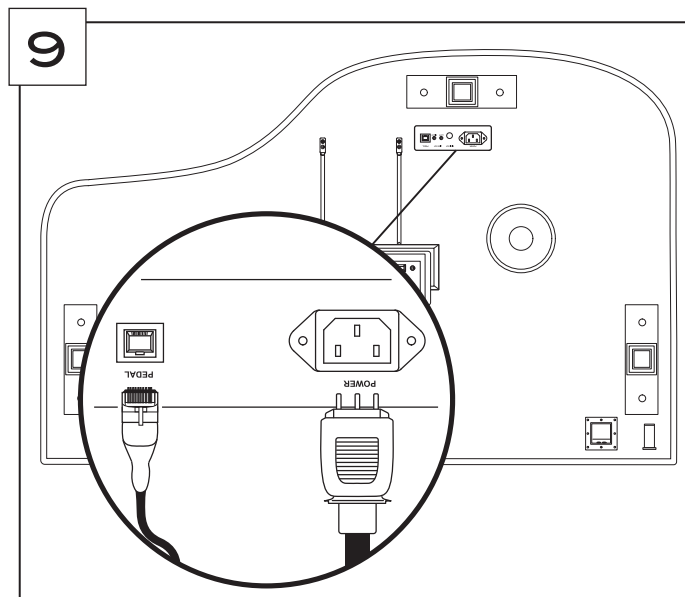

10. With your piano in its final position, locate the two pedal feet on the bottom of the pedal support. Turn them counter clockwise until they both make firm contact with the floor surface. (If the pedals creak, this is not screwed down far enough.)

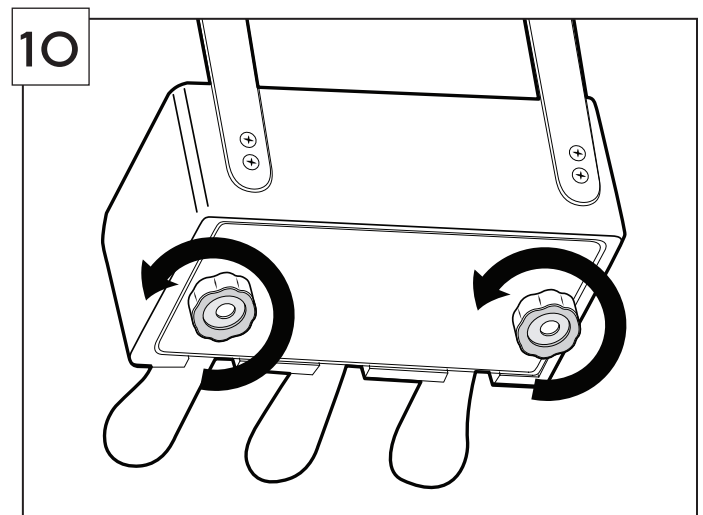

If you relocate the piano in the future, be sure to raise the feet back up first.



SYMPHONY GRAND II DIGITAL PIANO

11. Assemble the piano bench, located in its own box. Push insert A into the leg. Push wooden dowel C into the top of the leg. Add the nuts and washers in B to attach the leg, and use the supplied wrench D to tighten.

11

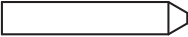
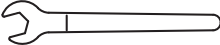
- A:  (x4)
- B:  (x4)
- C:  (x4)
- D:  (x4)

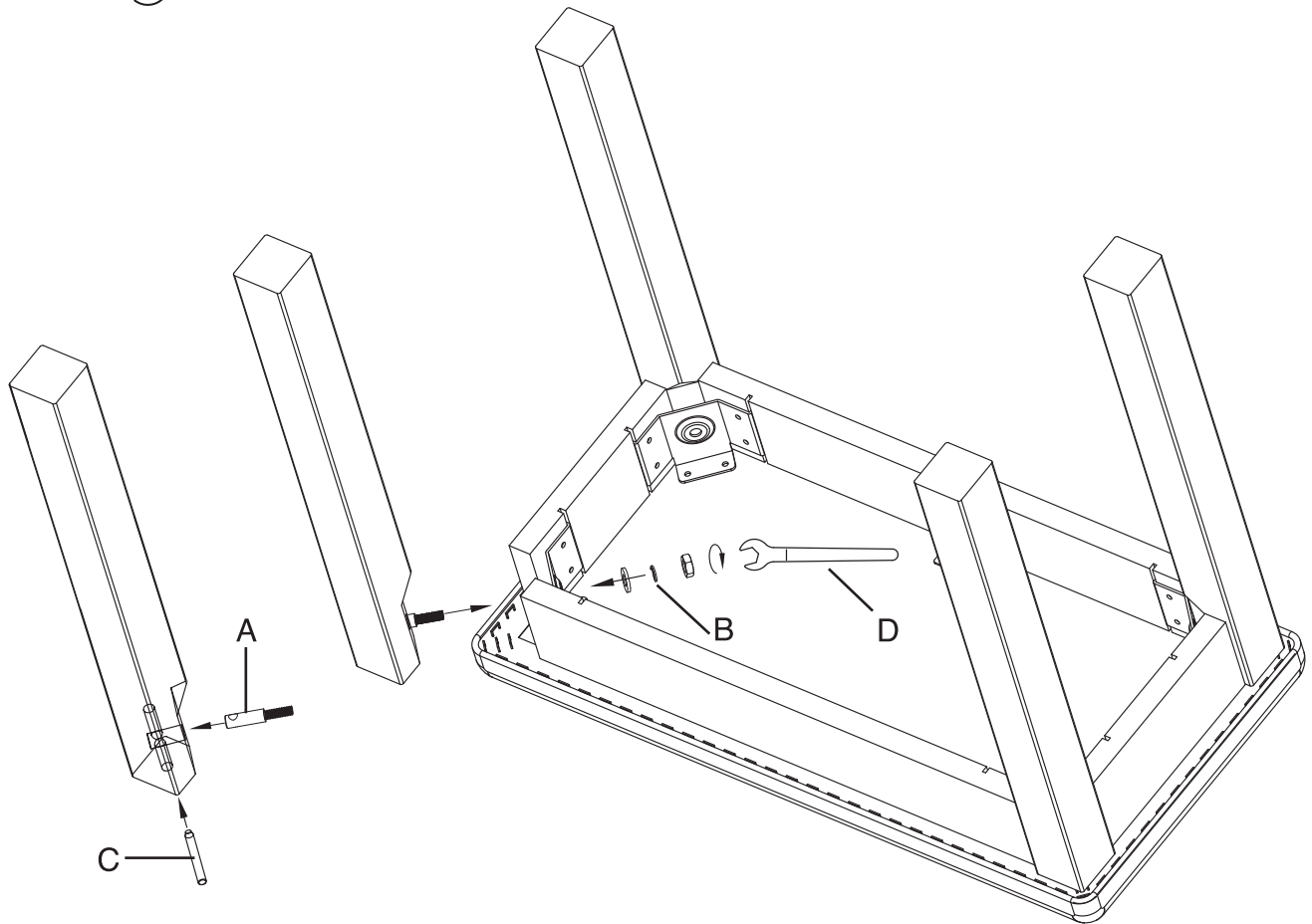

TAKING CARE OF YOUR DIGITAL PIANO

This Williams Symphony Grand II digital piano will provide years of musical enjoyment if you follow the suggestions listed below.

PRODUCT SERVICING

This product should be serviced by qualified service personnel when:

- The power supply cord or the plug has been damaged.
- Liquid has been spilled into the unit or it has been exposed to rain.
- The instrument does not appear to operate normally or exhibits a marked change in performance.
- The instrument has been dropped or the cabinet has been damaged.
- Please contact Williams support at 888-241-1582 for parts and service information.

HANDLING AND TRANSPORT

- Never apply excessive force to the controls, connectors or other parts of the instrument.
- Always unplug cables by gripping the plug firmly, not by pulling on the cable.
- Disconnect all cables before moving the instrument.
- Physical shocks caused by dropping, bumping, or placing heavy objects on the instrument can result in superficial or operational damage.
- Carefully check the volume control before playing. Excessive volume can cause permanent hearing loss.

CLEANING

- Clean the cabinet and panel with a soft, dry cloth. Do not use paint thinner or petrochemical based polishes.
- To maintain the luster of the keys and buttons, wipe with a clean, lightly dampened cloth, and then polish with a soft, dry cloth.

LOCATION

- To avoid deformation, discoloration, or more serious damage, do not expose the instrument to the following conditions: Direct sunlight, high temperatures, excessive humidity, excessive dust, strong vibration.
- Leave enough space around the piano for proper ventilation.
- This instrument contains digital circuitry and may cause or be susceptible to interference if placed too close to radio, television receivers, or mobile phones. If interference occurs, move the instrument further away from the affected equipment.
- Avoid placing vinyl objects on top of the instrument, vinyl can stick to and discolor the surface.

POWER

- Turn the power off when the instrument is not in use.
- To avoid damage to the instrument and other devices to which it is connected, turn the power of all related devices off prior to connection or disconnection of MIDI cables.
- Turn the power off if the main cable is damaged, or the instrument has been exposed to liquid.
- Do not switch the unit on and off in quick succession, as this places an undue load on the electronic components.
- Unplug the AC power during an electrical storm.
- Avoid plugging the AC power into the same AC outlet as appliances with high power consumption, such as electric heaters or ovens.

FRONT PANEL

LEFT SIDE

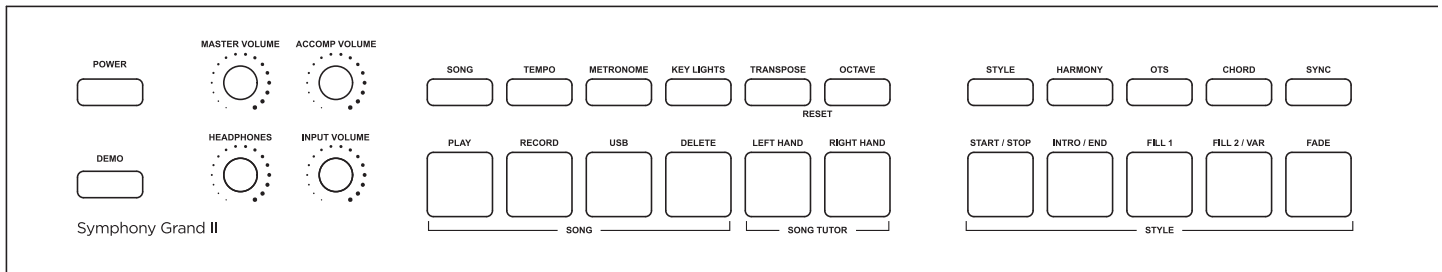

Power On/Off

This product has a power standby mode to switch off power automatically when not being used. To disable, see the Function settings.

Demo

Plays the factory demos

Master Volume

The overall output volume of the piano

Accompaniment Volume

Controls the output volume for Styles

Headphones

Controls the headphone volume

Input Volume

Controls the volume of the Aux Input

Song

Puts the piano in Song Mode

Tempo

Shows the tempo, editable with the data wheel

Metronome

Press the Metronome button to turn on the metronome. The LED will flash in tempo and click in headphones or speakers. Press it again to stop. Metronome settings are found in the Function menu page 1 (Tune/Click.)

Key Lights

Turns the lights above the keys on or off

Transpose

Transposes the key of the piano

Octave

Transposes the range of the piano keys 1 octave higher or lower.

Piano Reset

Pressing the Transpose and Octave buttons simultaneously will reset the piano.

Song Recorder/MIDI File Buttons

Play, Record, USB, Delete

Song Tutor Buttons

Song Teaching Mode for the 50 built-in songs with right and left hand part mutes. Press both Left and Right Hand buttons to turn on the Song Tutor Mode.

Style

Puts the piano in Style mode

Style Function buttons

These buttons control the functionality of the accompaniment styles.

- Start/Stop
- Sync
- Intro/End
- Fill1
- Fill2/Variation
- Harmony
- OTS
- Chord
- Fade

FRONT PANEL

RIGHT SIDE

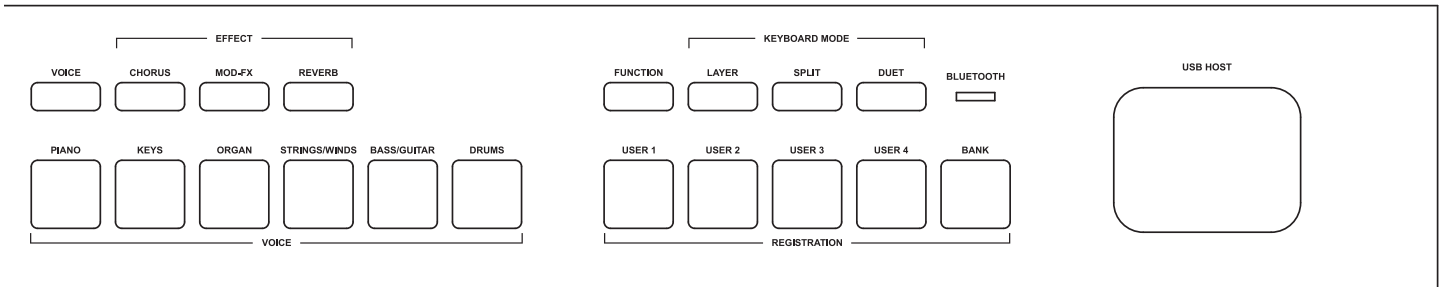

LCD Display

The display shows the current functionality of the mode you are in along with the parameters that can be adjusted in the mode

Display Function Buttons

The F1-F5 buttons work with the on-screen functions of the LCD display.

Value Dial

Changes values on screen

Category Buttons

Used to change between the Voice and Style categories

Page Buttons

Used to move the cursor on the screen between parameters

Voice Button

Activates the Voice mode

Chorus, ModFX, Reverb Buttons

Turns on and off the Chorus, ModFX, or Reverb effect assigned to the voice

Voice Select Buttons

(Piano, Keys, Organ, Strings/Winds, Bass/Guitar, and Drums) Pressing these buttons will switch on the sound group that is associated with the names printed above them. For categories with a slash in the name (like Guitar/Bass), press the button a second time to get to the other category.

Function

Opens the Function screen allowing you to change global settings for the piano

Layer

Used to allow you to layer two voices together on the keyboard

Split

Splits the keyboard voices between right and left side

Duet

Sets the keyboard to allow two players to play notes in the same octaves

Bluetooth

This light shows when a device is paired with the piano

Registration Buttons

1-4 and Bank to recall keyboard settings

USB Host Slot

Plug in a USB thumb drives to record and play Audio and MIDI files on the drive

I/O PANEL AND JACKS

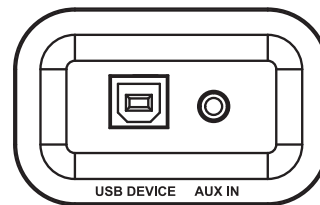
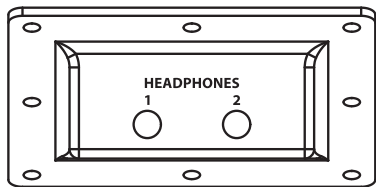

UNDERNEATH THE KEYBOARD

Headphones 1 and 2

The speakers will continue to play when Headphone jack 2 is connected. Headphone jack 1 will disconnect the speakers when headphones are connected. Both can be used together for music lessons.

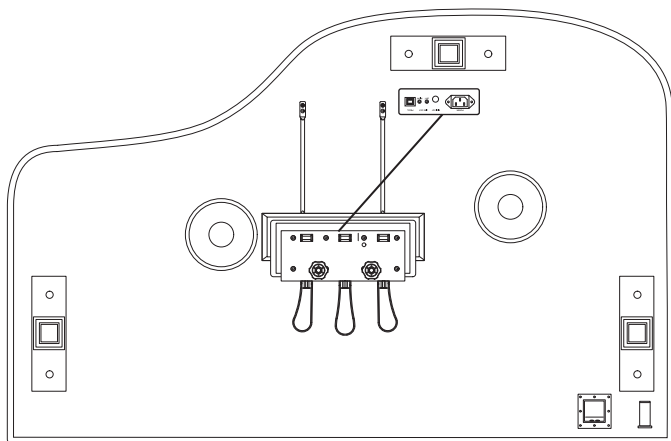

BEHIND THE MUSIC REST

USB to Computer Connector

The USB connection is to connect the Symphony Grand to a computer, or tablet device that is MIDI Class Compliant. The USB connection is Class Compliant so no special USB drivers are needed on your computer.

Aux Input

This stereo 1/8" jack accepts an audio input from an external audio source such as a computer or mobile device. The audio input will be mixed with the audio output of the piano.

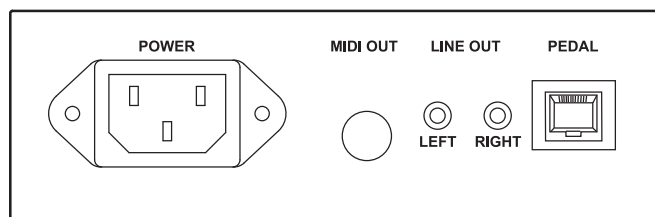

BOTTOM OF PIANO

AC Power Socket

Connection for the AC power.

MIDI Output Jack

For connection to external MIDI device such as sound module.

Line Outputs

These two 1/4" jacks take the audio output directly out of the piano to a line level source such as an amplifier.

Sostenuto, Sustain and Soft Pedal Input

Connects the built-in pedals located at the bottom of the piano.

OPERATIONS

Powering on the Symphony Grand II

Press and hold the POWER button on the left of the front panel.

DEMO SONGS

To Play a Demo Song

Press the Demo button and use the value dial to select the demo song. To exit the demo mode press the Demo button again.

Main Playing Modes

The Symphony Grand II has three main modes for playing operations, Voice, Styles and Song. See below explanations for the modes.

KEY LIGHTS

The Symphony Grand II has lights above each key. These light up to show which key you're playing, show split points, and other functions. To disable these keyboard lights, press the Key Lights button on the front panel. The Key Lights work great with educational software like the included Skoove app. See the flyer that was included with your piano to get your free copy.

VOICE MODE

The Voice mode is for selecting the sound you want to play on the keyboard. When the Symphony Grand II first starts up the first Voice is the Grand Piano.



Selecting Voices

To change voices you can simply turn the Value dial to play any of the sounds when using the main screen. To look at the sounds available in the Symphony Grand II, press the Voice button. The screen will show a list of sounds and you can scroll with the value dial as you play the keyboard to audition them.

If you are looking for a specific group of sounds there are Function buttons below the display (F1-F5) that you can press to take you to that group. For instance if you are looking for Organs you can press the F2 button. The display will change and only show the organs. You can use the F-keys under the display, the Voice category buttons (Piano, Keys, etc.) or the Category buttons next to the display to change voice categories.

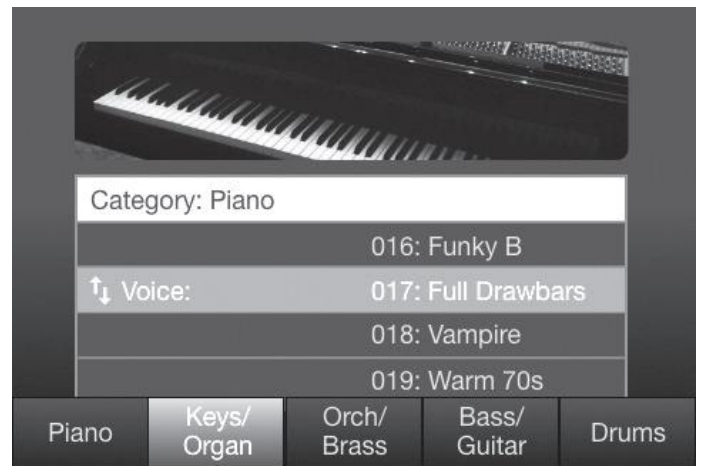

SYMPHONY GRAND II DIGITAL PIANO

Editing Voices

Each Voice can be edited to your taste when you are in the Voice mode. Parameters such as reverb type and amount can be adjusted. When you make changes these will be kept in the memory of the Symphony Grand II until you change them or if you reset the Piano back to factory settings.

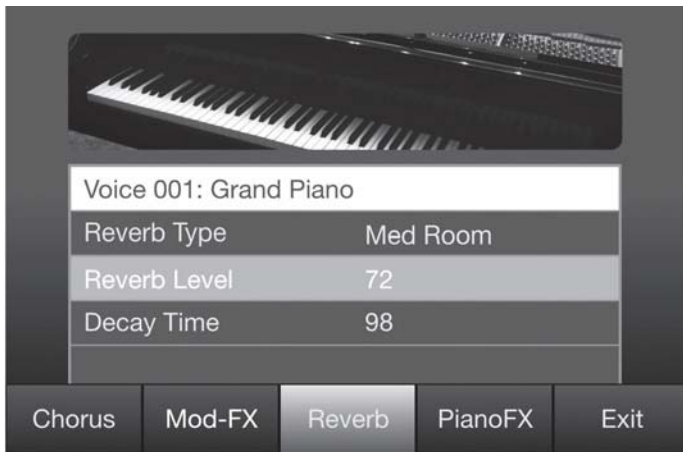

To enter the Edit Mode:

1. Press the VOICE button.
2. Select the Voice you want to edit
3. Select the Edit tab with the F5 button
4. Depending on the type of voice you will see up to 4 tabs at the bottom of the screen, which are accessed by the Function buttons below the screen. See the list below to review the edit parameters.
5. To Exit the Edit mode, press the F5 Exit button.

Voice Effect types and parameters:

F1 – Chorus

- Chorus Type: Presets
- Chorus Level: Amount of effect
- Chorus Depth: Intensity of effect

F2 – ModFX

There are two types of effects. Most have these parameters:

- ModFX Type: Presets
- ModFX Depth: Amount of modulation
- ModFX Rate: Rate of modulation
- Overdrive: Distortion

When the ModFX type is set to "Rotary," the Depth and Rate parameters are changed to:

- Rotary Speed: This selects the speed of the rotating speaker effect. the default is "Pedal," where the speed is controlled by the sustain pedal. Pressing the pedal down accelerates to fast speed. This parameter can also be set to "Slow" or "Fast."

F3 – Reverb

- Reverb Type: Presets and room types
- Reverb Level: Mix amount
- Decay Time: Length of reverb

F4 – Volume and Piano FX (on Pianos Only)

- Voice Volume: Master volume for that voice
- Sustain Pedal Noise: Volume of noise when you press down the sustain pedal
- Sustain Layer FX: When you press down the sustain pedal to lift the damper, this is how much of the open strings you will hear
- Key Release Noise: The volume of the sound when you release a key

SPLITS

Split Mode allows the keyboard to be divided into two sections so that different voices may be played with the left and right hands. The volume may be independently adjusted for each voice, the Split Point (the highest note played with the left hand) may be adjusted and the Split Voice may be changed as desired.

To Enter Split Mode

Press the [SPLIT] button. The Split (left hand) voice will be the Acoustic Bass and the last Split Point used. The lower split point will be shown with the key lights turning green.

To Change the Split Mode Settings

The quickest way to change split settings is to press and hold the Split button. Hold the Split button and press a key to make a new split point. Hold the Split button and turn the data wheel to select a new lower split sound.

Alternately, press the FUNCTION button. On the Trans/Split page you can change parameters for the Split mode by selecting the setting you want with the page buttons to adjust and turning the Value dial to change the parameters.

Split Point - B1: 47 (MIDI Notes). This determines the split point on the keyboard when the Split Mode is enabled. The key label and MIDI note number are both shown.

Split Volume - Default is 100

Split Octave - Default is 0

LAYERS

The Layer Mode allows you to layer up to 2 different sounds on top of each other.

To Enter Layer Mode and Select Sounds

1. Select the primary sound you want to use.
For this example use the Grand Piano.
2. Press the Layer Button. You should be hearing both the Grand Piano and a String section sound together.

3. To change the 2nd layer (Strings) press and hold the Layer button. You will see the Strings sound on the display.
4. While holding down the Layer button turn the dial to select another sound and then release the Layer button.
5. The Layer button will go off. Press it again. You should now hear the new sound that you selected play when you play on the keyboard.

To Change the Layer Mode Settings

Press the FUNCTION button. Press F1, press the right Page button, then adjust the Layer Volume by turning the Value dial.

STYLE MODE

The Style Arranger Mode is a feature that allows you to play pre-programmed arrangements (drums, bass, keys, guitar, etc) with your left hand and play the lead melody on your right hand.

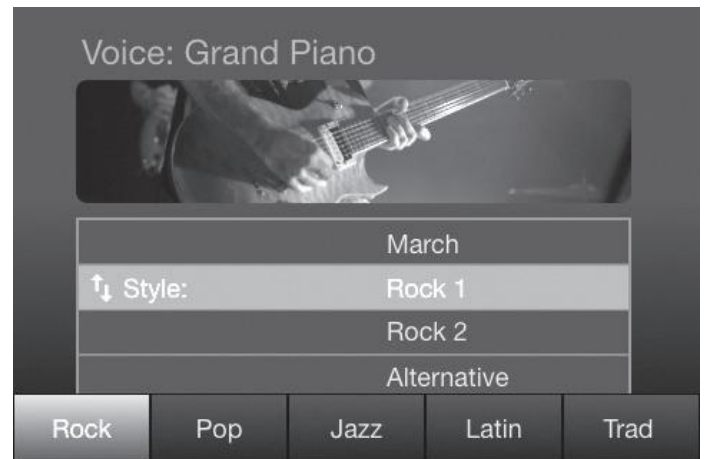

Selecting Styles

1. Press the STYLE button.
2. The Display will show a list of Styles that you can select from to play. Use the F-keys to select a style type (Rock, Jazz, etc.)
3. Turn the Value Dial to highlight the Style that you want to play.

SYMPHONY GRAND II DIGITAL PIANO

Controlling the Styles

1. Press the Start/Stop button on the Transport controls (in the Styles section). You should hear a drumbeat playing.
2. Press the CHORD button. The lower section of the keyboard should have green lights.
3. Press a key on the left side of the keyboard (try the C below middle C). You should start hearing a musical arrangement playing along with the drumbeat.
4. As you play individual notes on the keyboard you can hear the arrangement transpose to a new key.

Musically Controlling the Styles

1. Press the SYNC button. The LED will light.
2. Press the Intro/End button. It's LED will light.
3. Make sure the CHORD buttons is on, then play a C key on the left side of the keyboard. The Style will start playing the intro and then automatically a regular accompaniment in the key of C.
4. Play G key. At this point the accompaniment will change to the key of G.
5. Press the Fill1 button. The accompaniment will now play a fill and continue to play.
6. Press the Fill2/Variation button. There will be another fill and there will be a variation of the arrangement.
7. Press the Intro/End button. The arrangement will now play to the end and then stop.

Other Style Functions

Harmony - When Chord mode is enabled the right hand part will automatically create a harmony based on the note you are playing.

OTS - (One Touch Sound) - When this is enabled the right hand part sound will be automatically selected to compliment the arrangement that is selected. You can change this assignment if desired by selecting a different voice.

Chord - When enabled the key of the rhythmic arrangement will be based on the root note of what is played by the left hand. For instance if you play the C note octave below middle C, the chords will

be C. To play harmonies other than major chords you will need to play the interval that will change the chord from a major to a minor. For instance if you play a C, Eb and G the C chord will become minor. If you play C and Bb the Chord will become C7. See the appendix, pages 36 and 37, for examples of playing harmonies.

Fade - When you press this button the arrangement volume can be faded in or faded out.

For Fade ins, press the SYNC button then press the Fade button. When you play a note on the left side of the keyboard you will hear the arrangement fade in.

For Fade outs, simply press the Fade button. You will hear the arrangement fade out.

SONG MODE

There are two different functions in the Song Mode of the Symphony Grand II, Internal and USB Song modes.

If you have a USB flash drive inserted into the HOST USB drive slot on the front panel you can switch between these two modes. If you don't have a USB drive inserted you will only be in Internal Mode.

USB Song Mode



The Symphony Grand II can play standard MIDI files directly from a USB flash drive (formatted in a standard Windows FAT 32 format).

Insert the drive into the HOST USB drive slot. The display will show a list of Songs (MIDI files) on the drive that can be played.

To Play MIDI files from the USB device

1. Press the Song button. If the USB device is inserted in the USB Host port but the screen shows the Internal song mode, press the USB button to change the screen to the USB song mode to view the files.*
2. From the list of Song files (MIDI files) listed on the screen, highlight the song name with the Value Dial.
3. Press the Play Button in the Song Recorder Section of the front panel.
4. While the USB song is playing, press the F5 key to change the volume.
5. To Stop the Song press the Play button again.

To load a Song from the USB Device to the internal memory.

1. Insert a USB drive into the USB drive port
2. Press the Song Mode Button. The display will show a list of Songs (midi files) on the drive.
3. Use the Value dial to select the song to play.
4. Press the F1 button which shows "save to internal". It will then show a message "saving". The selected USB song/midi file will be stored to internal memory and the original internal recording song will be call "localsong.mid" Any existing song will be replaced with the Song/MIDI file.

To switch between the Internal and USB modes press the USB button. You will see the display change from "Internal" or "USB".

**All songs should be on the main directory of the drive. Be sure not to put the MIDI files inside of folders otherwise the Symphony Grand II will not be able to view the files.*

Recording a Song using the Internal Song Mode



The Symphony Grand II can record your performance on several tracks and can be stored on a USB thumb drive.

There are 4 tracks with the Song Recorder.

Track 1- Can record the Grand Piano with effects or any other Voice instrument sound. There can be layers or splits on the Voices on track 1.

Tracks 2-3 - Can record any of the Voices, however it will not support any splits or layers.

Track 4 – For recording a Style. For instance if you select a Style you can record the Intro, Variations, Fills and the Ending as you perform them.

Recording an Internal Song

1. Select a Voice you want to record such as the Grand Piano
2. Press the Record button on the front panel in the Song Recorder section. The LCD will display the current song. The Record light will flash, then begin recording as soon as you play the keyboard.
3. Press the Record button to stop recording. The first tab will change from "Track 1 Null" to "Track 1."
4. Press the Play button in the Song Record section to hear your performance played back.
5. Select another voice to record.

SYMPHONY GRAND II DIGITAL PIANO

6. Press the Record button then press the Function button 2 under the display to select Track 2 to record on. Start playing your voice along with the one that is already recorded.
7. Press Record to stop the recording and press Play to hear both tracks play together.
8. Repeat the process for the 3rd track.

If you want to record a Style for your song you can do that directly on Track 4. It's recommended that you start with recording the Style on Track 4 first and then record the other parts.

1. To record a Style into the Song Recorder select a preset style that you want to record and then return to the Song Record.
2. Press the Sync button on the Style transport buttons to prepare the Style to be ready to record.
3. Press the Record button. Then press the keys for the Style to record your performance of the Style accompaniment.

To Delete a Song

1. Press the Delete button on the front panel Song Recorder section. The name of the song will flash on the display.
2. Press the Delete button again and then the display will show "No Recording".

To save your song to a USB drive

3. Once the recording of the tracks are completed you can save the Song onto a USB drive
4. Insert a USB drive in the USB device port
5. Press the F2 button which shows "Save to Drive", it will show a message "loading", and then the internal recording song "localsong.mid" will be store to the USB drive and named "songxx.mid"

Recording an Audio File using the USB Song Mode

1. Insert a USB drive into the USB drive port
2. Press the Song Mode Button. The display will show a list of Songs (WAV and MIDI files) on the drive. If the USB device is inserted in the USB Host port but the screen shows the Internal song mode, press the USB button to change the

screen to the USB song mode to view the files.

3. Press the Record button on the front panel in the Song Recorder section. The USB file list will show "Rec:WAV_0001.WAV" and begin recording.
3. Press the Record button to stop.
4. Press the Play button in the Song Record section to hear your performance played back.

To record a MIDI file to the USB drive, first record it to Internal, press USB to switch to the USB list, then press "Save To Drive."

REGISTRATIONS

Registrations store setup information that can be recalled. Each Registration will save your current setup information of multiple parameters (see the list below). There are 4 Registrations per bank with up to 4 banks that can be stored in the internal memory of the Symphony Grand II.

What is stored in a Registration

- Voice
- Style
- Tempo
- Transposition
- Split Voice settings - Svoice
- Layer Voice settings - Lvoice
- Split On or Off - Split On/Off
- Layer On or Off - Layer On/Off
- Main Voice Octave - M.Oct
- Split Voice Octave - S.Oct
- Main Tuning - Tune

To select a Registration press a Registration button you want and the current settings (default) will apply.



To View a Registration

Press and hold down a specific Registration button for 3 sec. The Registration screen will appear on the LCD.

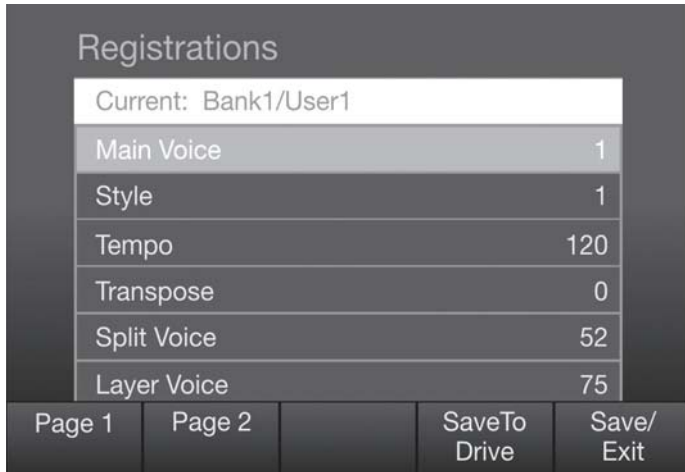

To Edit a Registration

1. Use the page buttons to select a parameter on the screen to edit (Voice, Style, Tempo, Trans).
2. Use the Value knob to change the parameter setting.
3. Press the F5 button to save your settings.
4. To back up your registration settings to a USB drive, press the F4 button.

SONG TUTOR

The Symphony Grand II has 50 built-in songs that are designed to help you learn the left and right hand parts separately.

1. To Play a Song and mute the parts use the steps below.
2. Press both Right and Left buttons to activate the Song Tutor mode. The first song will show up on the display and you will hear a count off measure then the song will play.
3. To change the song turn the Value dial you will see the different names show on the display.
4. To mute the Left or Right hand part press button for the hand you want to mute. The LED on the button will turn off.

5. To unmute the part press the button again.
6. To turn off Song Tutor mode press both buttons again.

You can start and stop a Song when it selected by pressing the F1 button on the LCD display. There are start and stop icons above the F1 button to indicate the play status.

To get the sheet music to these songs go to www.williamspianos.com and download the PDFs.

FUNCTIONS

The Functions settings in the Symphony Grand II are the Main System settings that change the entire piano. Press the Function button to enter this mode, select one of the F-keys, use the page buttons to select a setting, then use the value dial to change it.

Main Settings Page 1: Tune/Click

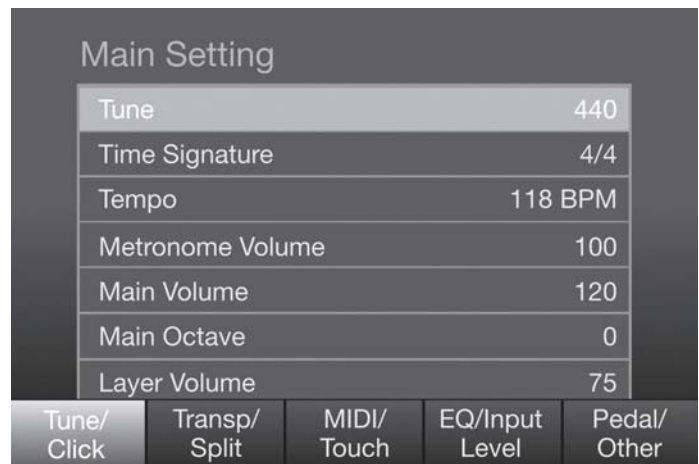

Tune

Master tuning for the piano. The default is 440.

Time Signature

Used for the metronome. The default is 4/4 and the following options are available to toggle through: 1/4, 2/4, 3/4, 4/4, 5/4, 6/4, 3/8, 6/8, 7/8, 9/8, and 12/8.

Tempo

Tempo for the metronome and styles. The default is 118bpm, but styles can have their own tempo as

SYMPHONY GRAND II DIGITAL PIANO

well. Press and hold Tempo from the main screen for a faster method to set the tempo.

Metronome Volume

Volume of the click. The default is 100.

Main Volume

Normally the Volume for the piano is controlled by the Volume knob on the front panel. There is also an overall main volume control in the Function Mode. Setting this higher than 120 may cause distortion in the speakers.

Main Octave

Transposes the keyboard by an octave. The "Octave" button is a shortcut to this setting.

Layer Volume

Changes the volume of the secondary sound when in Layer mode.

Main Settings Page 2: Transpose/Split

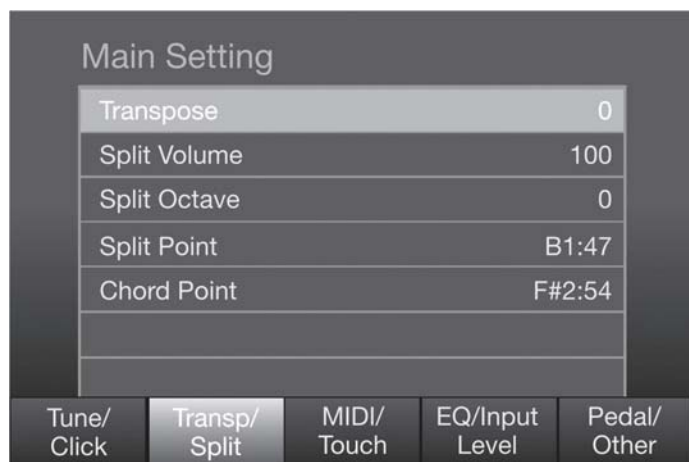

Transpose

Transposes the keyboard by a fixed amount. The Transpose button is a shortcut to this setting.

Split Volume

Split Volume - (Default is 100) This determines the volume of the left hand split sound.

Split Octave

(Default is 0) This determines the Octave setting of the split left hand sound.

Split Point

(Default is B1:47). This determines the MIDI note where the split is set on the keyboard when in Split Mode. For a quicker method to change the split point, hold the Split button and hit a key on the keyboard.

Chord Point

This determines the MIDI note where the chord split point is set on the keyboard when in Chord Mode. The default is F#2:54.

Main Settings Page 3: MIDI/Touch



MIDI Local

The default is On. Switch this off if you are looping MIDI to and from a computer DAW.

MIDI Channel

This is the MIDI channel for the main sound when used with a computer or tablet DAW. The default is 1. You can connect to MIDI using the USB Device jack behind the music rest or with Bluetooth MIDI (if supported by your app.)

Touch Curve

The feel of the keyboard can be adjusted to the players touch by using the Touch Sensitivity controls. The default is Normal. You can adjust to your playing (Low, High, and Fixed)



Panic

Use this function to stop stuck notes if you encounter this with MIDI devices.

Auto Power Off

This function will switch your piano off when not used for a period of time. The range is off or from 20-60 minutes.

Bluetooth

Switch Bluetooth on to pair the piano with a device like a smartphone or laptop. You can send either Audio or MIDI from your device, but not both at once. See page 22 for more information on Bluetooth.

Main Settings Page 4: EQ/Input Level



EQ Settings

You can change the Overall EQ settings for the piano to increase or decrease the high and low frequencies. Normally the piano is set at a flat EQ. However certain types of rooms may affect the sound quality of your piano. By adjusting the EQ settings you can make the piano fit the room's sound better.

You can change parameters for the EQ by selecting the setting you want to adjust with the page buttons and turning the Value dial to change the parameters. The range is +/- 12dB and the default is 0.

USB Audio Input Level

When you plug a tablet or computer into the USB

Device jack, the piano acts as a 2-channel audio interface. This is great for playing the sounds from educational apps while controlling them with MIDI. (You may need a USB adapter for your tablet or laptop.) This setting controls the volume coming from your computer or app.

Bluetooth Audio Input Level

This controls the volume level coming out of your Bluetooth device over audio and then playing through the speakers. For example, you may want to turn an app's audio level down so that you can play along.

Main Settings Page 5: Pedal/Other



Left Pedal Assign

The default setting is Soft, where this pedal works like the soft pedal on a Grand Piano. It can also be switched to Start/Stop to start a Style playing.

Mid Pedal Assign

The middle pedal is normally a Sostenuto pedal like a grand piano. It sustains the notes you were holding when you pressed it, but new notes don't have the pedal-down effect. It can also be set to trigger the Fill1 button when using Styles.

Song Play Mode

The default is Sequence, where all songs on a USB drive will play one after the other like a jukebox. You can also set it to Repeat to repeat a MIDI file over and over.

SYMPHONY GRAND II DIGITAL PIANO

Piano Master Volume

This is the master volume of the whole piano. It can be turned down if you don't want the piano volume to go as loud.

MIDI Input Volume

This controls the master volume of MIDI files and demos.

RESETTING TO THE FACTORY DEFAULT

To reset the Piano to the factory settings. Turn on the keyboard while pressing Transpose and Octave. Hold these buttons until you see "Factory Reset" at the top of the piano. This will erase any settings you have made on the Symphony Grand II.

MIDI FUNCTIONS

The Musical Instrument Digital Interface (MIDI) is an industry-standard protocol that enables electronic musical instruments such as keyboards, computers, drum machines, etc. to communicate, control, and synchronize with each other. MIDI transmissions consist of electronic codes that communicate notes to be played, the instrument, pitch or intensity with which notes are to be played, and controlling codes such as volume, vibrato, cues and clock signals. The Symphony Grand II has several functions that facilitate its use as a MIDI device or controller. The input/output module on the bottom side of the piano cabinet has a MIDI output which can be connected to the input of MIDI device that will allow you to play sounds in the other device from the keyboard of the Symphony Grand II.

MIDI Channels

The Symphony Grand II has 16 channels numbered from 1-16. Each channel is responsible for a voice. When the instrument receives MIDI information from an external device, the active channel is determined by the control message.

The transmission channels are fixed as follows:

Channel 1 Master voice (keyboard)

Channel 2 Split voice (keyboard)

Channel 3 Layer voice (keyboard)

Local On/Off

Turning the Local On/Off function to "Off" will disconnect the keyboard from the internal sound engine of the piano. The Symphony Grand II may then be used as a MIDI controller to control other MIDI devices or virtual instrument software running on a computer, without playing the sounds on the piano. Additionally, it may be desirable to turn local playing off for other requirements such as when using MIDI sequencing software on your computer. See the Function Settings for setting the Local On or Off as well as the MIDI Channel settings.

Multitimbral Mode

The Symphony Grand II is able to receive MIDI information on up to 16 channels simultaneously. If you plan to use your piano with a multitrack MIDI recording system, you can record up to 16 different parts using the Symphony Grand II voices, each played back individually on different MIDI channels. To ensure your recorded part is played back with the correct voice make sure to press the voice button first and play your part second.

NOTE: Because the Symphony Grand II is receiving playback information via MIDI, the currently selected voice on the piano may not correspond to the voice being played back.

For more specific information on the MIDI capabilities of the Symphony Grand II please check the MIDI implementation Guide at the end of the manual.

USB Functions

The Symphony Grand II also has a USB MIDI to computer port behind the music rest which allows for communication with a computer device for MIDI input and output. The USB connection is class compliant, which means you don't need any specific drivers when using a Windows or Apple computer. It can also work with an Apple iPad™ for



MIDI communication if you use an Apple camera connector kit with a standard USB cable.

The Symphony Grand II can also receive audio from your computer. By going into your Computer's control panel for Audio you can specify the Symphony Grand II as an audio device. After doing this the audio from your computer can be played into the Symphony Grand II's audio system. This can be good for performing along with audio files with your built-in sounds on the Symphony Grand II, or working with educational apps on your tablet.

BLUETOOTH FUNCTIONALITY

The Symphony Grand II is able to work with computer devices using Bluetooth protocol. This will allow you to play audio on your computer or tablet device into the Symphony Grand II's sound system. You can also use Bluetooth to send MIDI data bi-directionally between the computer or tablet as well. It is not possible to use Audio and MIDI simultaneously because this may cause timing delays with the MIDI functions.

You can also send MIDI messages to and from the Symphony Grand II to your computer or tablet device.

Audio Functions

Pairing- In order for Bluetooth to work you must pair two devices. This will allow them to communicate with each other. Make sure that the Bluetooth LED is lighted on the front panel to indicate that the Bluetooth mode is on. If it is the Symphony Grand II should be discoverable on your device. If the LED is not on then you should go into the function mode to enable Bluetooth. See the section for how to turn on Bluetooth below.

On your computer or tablet you need to enable the Bluetooth mode. Once you have enabled Bluetooth you can select the Symphony Grand II as a device. It should show up on your computer or tablet as "Symphony Grand II".

Once you have selected the Symphony Grand II you can now play audio from the computer or tablet device to the Symphony Grand II. Audio can only be sent from the computer or tablet to the Symphony Grand II. You cannot send audio from the piano to your computer.

Bluetooth MIDI

In order to send and receive MIDI messages with the Symphony Grand II you need to have an application on your computer or tablet that has MIDI Bluetooth functionality. As long as the Bluetooth Mode is on it should be discoverable on your computer or tablet to set up pairing and communication.

Turning Bluetooth Mode on and off.

Bluetooth should be turned on with the Symphony Grand II. If you find that the Bluetooth ID is not shown on your computer or tablet, check to make sure that Bluetooth is turned on. The LED on the front panel should be lit.

Bluetooth is enabled using Function mode:

1. Press Function
2. Press Main page 3. Bluetooth should be set to on.

After your computer or tablet device has paired the Symphony Grand II you should be able to send Audio or MIDI to the keyboard.

If you have already paired the Symphony Grand II with a Bluetooth device, you will need to unpair it from that device before trying to pair with another device.

SYMPHONY GRAND II DIGITAL PIANO

SPECIFICATIONS

Keyboard	88 weighted, velocity-sensitive keys
Voices	172 voices (including GM)
Polyphony	256
Arranger Styles	180
Voice Control	Layer, Touch, Split
Pedals	Sustain, Sostenuto and Soft pedals
Demo Songs	14 Demo and 50 Song Tutor songs
MIDI Transmit Settings	Local Control, Channel
Connectors	USB (x2), 1/8" stereo aux in, 2 1/4" line outputs and 1/8" stereo headphones (x2)
Speakers	8 Total - 2 high, 2 mid, 2 low, 2 panel, 100 watt power amplifier
Dimensions	55" (Width) / 37.8" (Depth) / 36.5" (Height to top of body)
Weight	225 Lbs.
Supplied	Owner's Manual, Power Cable, Bench, Adjustable Wrench

VOICE LIST

Order on Screen	PG Change	Display Name	Category / Group
1	0	Grand Piano	Piano
2	1	Bright Piano	Piano
3	2	Rock Piano	Piano
4	PC-2 / MSB-110 *	Emotional Piano	Piano
5	3	Honky Tonk Piano	Piano
6	PC-2 /MSB-109 *	Grand Layered	Piano
7	4	Electric Tine Piano	Keys
8	PC-4-MSB- 109*	Rock Electric Piano	Keys
9	PC-4-MSB- 110*	Wah Electric Piano	Keys
10	5	Electric Piano Reed	Keys
11	PC-5-MSB- 109*	Funky Reed Piano	Keys
12	PC-5-MSB- 110*	80's Electronic Piano	Keys
13	6	Harpichord	Keys
14	PC-7-MSB- 109*	Wah Clavinet	Keys
15	7	Clavinet	Keys
16	PC-18/MSB-111*	Smiley Organ	Organ
17	PC-18/MSB-112*	Funky B	Organ
18	PC-18/MSB-113*	Top & Bottom Drawbars	Organ
19	16	Full Drawbars	Organ
20	17	Percussion Organ	Organ
21	18	Rock Organ	Organ
22	PC-18/MSB-114*	Rock Vibes	Organ
23	PC-18/MSB-110*	OverDrive Rock Organ	Organ



Order on Screen	PG Change	Display Name	Category / Group
24	PC-17/MSB-109*	60's UK Organ	Organ
25	PC-17/MSB-110*	60's Ital Organ	Organ
26	19	Cathedral Pipe Organ	Organ
27	20	Reed Organ	Organ
28	21	Accordion	Keys
29	22	Harmonica	Keys
30	23	Bandolin	Keys
31	8	Celesta	Keys
32	9	Glockenspiel	Keys
33	10	Music Box	Keys
34	11	Vibraphone	Keys
35	12	Marimba	Keys
36	13	Xylophone	Keys
37	14	Tubular Bells	Keys
38	15	Dulcimer	Keys
39	24	Nylon Guitar	Guitar
40	25	Steel String Guitar	Guitar
41	26	Jazz Guitar	Guitar
42	27	Clean Guitar	Guitar
43	PC-27/MSB 109*	Chorus Guitar	Guitar
44	28	Muted Guitar	Guitar
45	29	Overdrive Guitar	Guitar
46	30	Distorted Guitar	Guitar
47	PC-38/MSB 109*	Overdrive Chords	Guitar
48	PC-38/MSB 110*	Distorted Chords	Guitar
49	PC-38/MSB 111*	Crunch Chords	Guitar
50	31	Guitar Harmonics	Guitar
51	PC-31/MSB 109*	Wah Guitars	Guitar
52	32	Upright Bass	Bass
53	33	Fingered Bas	Bass
54	PC-33/MSB 109*	Muted Bass	Bass
55	34	Picked Bass	Bass
56	PC-33/MSB 110*	Rock Bass	Bass
57	35	Fretless Bass	Bass
58	36	Slap Bass 1	Bass
59	37	Slap bass 2	Bass
60	38	Synth Bass Acid	Bass
61	39	Synth Bass Reso	Bass
62	PC-39/MSB-111*	Synth Bass Rave	Bass
63	PC-39/MSB-112*	Synth Bass Techno	Bass
64	PC-39/MSB-114*	Synth Bass Perc	Bass
65	PC-39/MSB-115*	Synth Bass Layered	Bass
66	PC-39/MSB-116*	Synth Bass Wow	Bass
67	40	Violin	Strings

SYMPHONY GRAND II DIGITAL PIANO

Order on Screen	PG Change	Display Name	Category / Group
68	41	Viola	Strings
69	42	Cello	Strings
70	43	String Bass	Strings
71	44	Tremolo Strings	Strings
72	45	Pizzicato Strings	Strings
73	46	Harp	Strings
74	47	Timpani	Strings
75	48	Symphonic Strings	Strings
76	49	Slow Strings	Strings
77	50	Synth Strings 1	Strings
78	51	Synth Strings 2	Strings
79	52	Choir Aahs	Strings
80	53	Voices Oohs	Strings
81	54	Synth Voice	Strings
82	55	Orchestra Hit	Strings
83	56	Trumpet	Winds
84	57	Trombone	Winds
85	58	Tuba	Winds
86	59	MuteTrumpet	Winds
87	60	French Horn	Winds
88	61	Brass Section	Winds
89	62	Synth Brass 1	Winds
90	63	Synth Brass 2	Winds
91	64	Soprano Sax	Winds
92	65	Alto Sax	Winds
93	66	Tenor Sax	Winds
94	67	Baritone Sax	Winds
95	68	Oboe	Winds
96	69	English Horn	Winds
97	70	Bassoon	Winds
98	71	Clarinet	Winds
99	72	Piccolo	Winds
100	73	Flute	Winds
101	74	Recorder	Winds
102	75	Pan Flute	Winds
103	76	Bottle	Winds
104	77	Shakuhachi	Winds
105	78	Whistle	Winds
106	79	Ocarina	Winds
107	80	Square Wave	Keys
108	81	Saw Wave	Keys
109	82	Synth Calliope	Keys
110	83	Chiffer	Keys
111	84	Charang	Keys

Order on Screen	PG Change	Display Name	Category / Group
112	85	Synth Voice	Keys
113	86	Sawtooth 5th	Keys
114	87	Bass & Lead	Keys
115	88	New Age	Keys
116	89	Warm Pad	Keys
117	90	Poly Synth	Keys
118	91	Space Choir	Keys
119	92	Bowed Glass	Keys
120	93	Metal Pad	Keys
121	94	Halo Pad	Keys
122	95	Sweep Pad	Keys
123	96	Rain Pad	Keys
124	97	Sound Track	Keys
125	98	Crystal	Keys
126	99	Atmosphere	Keys
127	100	Brite Synth	Keys
128	101	Goblins	Keys
129	102	Echos	Keys
130	PC-102/MSB-109*	Big Pad	Keys
131	PC-102/MSB-110*	EDM Lead	Keys
132	PC-102/MSB-114*	Swirl Pad	Keys
133	PC-102/MSB-112*	Mod Pad	Keys
134	PC-102/MSB-113*	Synth Growl	Keys
135	PC-102/MSB-111*	Wobble	Keys
136	103	Sci Fi	Keys
137	104	Sitar	Ethnic
138	105	Banjo	Ethnic
139	106	Shamison	Ethnic
140	107	Koto	Ethnic
141	108	Kalimba	Ethnic
142	109	Bagpipes	Ethnic
143	110	Fiddle	Ethnic
144	111	Shenai	Ethnic
145	112	Tinker Bell	Ethnic
146	113	Agogo	Ethnic
147	114	SteelDrum	Ethnic
148	115	WoodBlock	Sound FX
149	116	Taiko	Sound FX
150	117	Melodic Tom	Sound FX
151	118	Synth Drum	Sound FX
152	119	Reverse Cymbal	Sound FX
153	120	Fret Noise	Sound FX
154	121	Breath	Sound FX
155	122	Seashore	Sound FX

SYMPHONY GRAND II DIGITAL PIANO

Order on Screen	PG Change	Display Name	Category / Group
156	123	Birds	Sound FX
157	124	Telephone	Sound FX
158	125	Helicopter	Sound FX
159	126	Applause	Sound FX
160	127	Gunshot	Sound FX
161	0	Standard Drum Kit**	Drums
162	8	Room Kit**	Drums
163	16	Power Kit**	Drums
164	24	Electro Kit**	Drums
165	25	Analog Drums**	Drums
166	32	Jazz Drum Kit**	Drums
167	40	Brushes Jazz Kit**	Drums
168	48	Orchestral Percussion**	Drums
169	56	Sound Effects Kit**	Drums
170	72	Dance Drums**	Drums
171	80	Standard Drum Kit 2**	Drums
172	88	Rock Kit**	Drums

* This sound must have a Bank select message to be selected

** MIDI Channel 10 only

DEMO SONG LIST

Piano Song	Display Name
1	Heavy Handed
2	Piano Concerto
3	Jazz Combo
4	Synthwave
5	Fantasy - Chopin
6	Top Down
7	New Day Orch
8	Cabriolet
9	Laguna
10	Latin Jazz
11	Funky Wurli
12	Ital Concerto
13	Blue Roads
14	Fortress - Bach



STYLE LISTS

Rock	Deep Chicago Blues Epic Rock Shuffle Garage Funk Band Grunge Guitar Rock R&B Rock Piano Rock & Roll 1 Rock Cha Cha Rock Pub Rock Soul Secret Blues	Simple Rock 1 Simple Rock 2 Slow Blues Southern Rock Shuffle Stadium Rock Surf Rock Open Road Down Home Bluesy Latin Rock	Rock n' Roll 60's Beach Party BarrelHouse Cruising Road Trip Movin' On Funky Rock Lite Rock Funky Rock 2 Mersey Beat	Rock Jam Swing Rock Rock Pop Rock The Isles Rock Ballad Upbeat Rock Rock Reggae Rock'n Roll Bld Rock Shuffle Twist it
Pop	Big Band Funk Big Piano Boogie Classic Pop Funk Club Dance Club Vibe Disco Club Electro Vamp 60s Vintage Pop 70s Vintage Ballad 70s Vintage Disco 90s Analog Love Ballad 90s Pop Funk Acoustic Ballad Baroque Ballad Love Ballad Nylon Guitar Ballad Party Rave	Worship Slow Ballad Original Funk Gospel Shuffle Fusion Guitar Chitown Blues 60's Soul 60's Soul Jam Modern Lounge Makin' Beats Reggae Swing Modern Ballad Electro Beat 80's Funk Mo Beats Pop Ballad Soul Ballad Pop Shuffle Slow Gospel	Gotta Be Funky Techno Groove Fusion Groove Funky thang 70's Disco Upbeat Ballad Organ Blues Hey Mon Techno 2 Funky Time Trance House Trax Hip Hop Disco Pop Pop Piano Ballad Pop Ballad 2 Funky Fusion 70's Pop	Pop Ballad 3 Pop Ballad 4 Pop Ballad 5 Dance Electro Electro Pop House Reggae Country Swing Walking Country Country 2 Step Country Ballad Country Waltz Country Tune Country Pop Country Swing Country Boogie
Jazz	Big Band Fast Big Band Mid Fusion Funk Jazz Funk Traditional Jazz	Piano Jazz Trio Modern Jazz Roaring 20's Jazz Waltz Jazz Quartet	Big Band Ballad Big Band Fast The Duke Big Band Dance Boogiewoogie	Jazz Ballad Quickstep Stride Swing
Latin	Party Pop Ocean Bossa 90s Tropical Funk Merengue Modern Samba Bossa Nova	Mambo Mariachi Rhumba Salsa Samba Beguine	Cha Cha Latin Club Spanish Theme Cha Cha 2 Tango 1 Tango 2	Tango 3 Tarantella Pop Bossa
Traditional	Bluegrass Fun Polka Broadway Shuffle Broadway Show Pick'n'Grin Hawaiian Hawaiian Shuffle Hawaiian Theme	Cartoon March Movie Ragtime Opening Night 70s Sitcom TV Show Slapstick Rag Boogie US March Traditional Polka Viennese Waltz	English Waltz Fox Trot French Waltz Pasodoble Polka Polka 1 Polka 2 Quick Fox Trot Ragtime	Swing Waltz March 1 Vienna Waltz Waltz Ballad March 2 Scottish Reel Greek Theme

DRUM SOUND LISTS

MIDI Note	Standard	Room	Power	Electro
	PC 0	PC 8	PC 16	PC 24
25	Click- SquareWave	Click- SquareWave	Click- SquareWave	Click- SquareWave
26	BrushTap	BrushTap	BrushTap	BrushTap
27	Scratch Push	Scratch Push	Scratch Push	Scratch Push
28	Scratch Pull	Scratch Pull	Scratch Pull	Scratch Pull
29	Stick	Stick	Stick	Stick
30	Snare	Snare	Snare	Snare
31	Bass Drum	Bass Drum	Bass Drum	Bass Drum
32	Bass Drum	Bass Drum	Bass Drum	Bass Drum
33	Vintage Bass drum	Vintage Bass drum	Vintage Bass drum	Hip Hop Bass drum
34	Studio Bass drum	Studio Bass drum	Maple Bass drum	808 Kick drum
35	Studio Snare Cross Stick	Shallow Brass Snare Cross Stick	Maple Snare Drum Cross Stick	808 Snare drum
C1 / 36	Funk Snare	Shallow Brass Snare	Maple Snare Drum	808 Snare drum 2
37	ElectroClap	Clap	Clap	808 Clap
38	Funk Snare Rim Shot	Shallow Brass Snare Rim shot	Maple Snare Drum Rim Shot	808 Snare Rim
39	Low Studio Tom	Low Funk Tom	Low Maple Tom	Low Electro Tom
40	Hi Hat Closed	Hi Hat Closed	Hi Hat Closed	808 Closed Hi Hat
41	Mid Studio Tom	Low Funk Tom	Mid Maple Tom	Low Electro Tom
42	Hi Hat Foot	Hi Hat Foot	Hi Hat Foot	Electo Hi Hat Foot
43	Mid Studio tom	Mid Funk tom	Mid Maple Tom	Mid Electro Tom
44	Hi Hat Open	Hi Hat Open	Hi Hat Open	808 Open Hi Hat
45	High Studio Tom	Hi Funk Tom	High Maple Tom	Mid Electro Tom
46	High Studio Tom	Hi Funk Tom	High Maple Tom	High Electro Tom
47	Crash Cymbal	Crash Cymbal	Crash Cymbal	808 Cymbal
C2 / 48	High Studio Tom	Hi Funk Tom	High Maple Tom	High Electro Tom
49	Ride Bow Cymbal	Ride Bow Cymbal	Ride Bow Cymbal	Electro Cymbal
50	China Cymbal	China Cymbal	China Cymbal	Electro China
51	Ride Bell Cymbal	Ride Bell Cymbal	Ride Bell Cymbal	Electro Ride Cymbal
52	Tambourine	Tambourine	Tambourine	Tambourine
53	Splash Cymbal	Splash Cymbal	Splash Cymbal	Splash Cymbal
54	Cowbell	Cowbell	Cowbell	Cowbell
55	Crash	Crash	Crash	Crash
56	VibraSlap	VibraSlap	VibraSlap	VibraSlap
57	Ride Bow	Ride Bow	Ride Bow	Ride Bow
58	Bongo Small	Bongo Small	Bongo Small	Bongo Small
59	Bongo Large	Bongo Large	Bongo Large	Bongo Large
C3 / 60	Conga Mute	Conga Mute	Conga Mute	Conga Mute
61	Conga	Conga	Conga	Conga

MIDI Note	Standard	Room	Power	Electro
	PC 0	PC 8	PC 16	PC 24
62	Tumba	Tumba	Tumba	Tumba
63	Timbale Hi	Timbale Hi	Timbale Hi	Timbale Hi
64	Timbale Low	Timbale Low	Timbale Low	Timbale Low
65	Small Agogo	Small Agogo	Small Agogo	Small Agogo
66	Large Agogo	Large Agogo	Large Agogo	Large Agogo
67	Cabasa	Cabasa	Cabasa	Cabasa
68	Maracas	Maracas	Maracas	Maracas
69	Short Whistle	Short Whistle	Short Whistle	Short Whistle
70	Long Whistle	Long Whistle	Long Whistle	Long Whistle
71	Guiro Short	Guiro Short	Guiro Short	Guiro Short
72	Guiro Long	Guiro Long	Guiro Long	Guiro Long
73	Clave	Clave	Clave	Clave
74	High Woodblock	High Woodblock	High Woodblock	High Woodblock
75	Low Woodblock	Low Woodblock	Low Woodblock	Low Woodblock
76	Low Quica	Low Quica	Low Quica	Low Quica
77	Hi Quica	Hi Quica	Hi Quica	Hi Quica
78	Triangle Mute	Triangle Mute	Triangle Mute	Triangle Mute
79	Triangle-Open	Triangle-Open	Triangle-Open	Triangle-Open
80	Cabasa	Cabasa	Cabasa	Cabasa
81	Shaker	Shaker	Shaker	Shaker
82	Bell Tree	Bell Tree	Bell Tree	Bell Tree
83	Castanets	Castanets	Castanets	Castanets
84	Mute Surdo	Mute Surdo	Mute Surdo	Mute Surdo
85	Open Surdo	Open Surdo	Open Surdo	Open Surdo

MIDI Note	Hip Hop	Jazz	Brush	Latin
	PC 32	PC 40	PC 48	PC 56
25	Click- SquareWave	Click- SquareWave	Click- SquareWave	Click- SquareWave
26	BrushTap	BrushTap	BrushTap	BrushTap
27	Scratch Push	Scratch Push	Scratch Push	Scratch Push
28	Scratch Pull	Scratch Pull	Scratch Pull	Scratch Pull
29	Stick	Stick	Stick	Stick
30	Snare	Snare	Snare	Snare
31	Bass Drum	Bass Drum	Bass Drum	Bass Drum
32	Bass Drum	Bass Drum	Bass Drum	Bass Drum
33	808 Kick drum	Jazz Bass drum	BD_Vintage	Surdo

SYMPHONY GRAND II DIGITAL PIANO

MIDI Note	Hip Hop	Jazz	Brush	Latin
	PC 32	PC 40	PC 48	PC 56
34	Hip Hop Bass Drum	Jazz Bass drum	Studio Bass drum	Surdo
35	Hip Hop Bass Drum	Shallow Wood Snare Cross stick	Deep Brass Snare Cross sticks	Timbale
36	Hip Hop Snare Drum	Shallow wood snare	Brush Snare	Timbale
37	Hip Hop Snare 3	Shallow wood snare	Brush Snare	Timbale Rim
38	Hip Hop Snare Drum 2	Shallow wood snare rim shot	Brush Snare Rim Shot	Low Maple Tom
39	Low Electronic Tom	Vintage Low Tom	Low Brush Tom	Shaker
40	Hip Hop Closed Hi Hat	Hi Hat Closed	Hi Hat Closed	Tumba
41	Low Electronic Tom	Vintage Low Tom	Low Brush Tom	Clave
42	Hip Hop Foot Hi Hat	Hi Hat Foot	Hi Hat Foot	Hi Hat Foot
43	Mid Electronic Tom	Vintage Mid Tom	Mid Brush Tom	Cabasa
44	Hip Hop Open Hi Hat	Hi Hat Open	Hi Hat Open	Hi Hat Open
45	High Electronic Tom	Vintage Mid Tom	Mid Brush Tom	Conga
46	High Electronic Tom	Vintage High Tom	High Brush Tom	High Maple Tom
47	Crash Cymbal	Crash Cymbal	Crash Cymbal	Ride Cymbal
48	High Electronic Tom	Vintage High Tom	High Brush Tom	China Cymbal
49	Techno ride	Techno ride	Crash Cymbal	Techno ride
50	Techno Crash	Techno Crash	High Brush Tom	Techno Crash
51	Electro Ride Cymbal	Electro Ride Cymbal	Techno ride	Electro Ride Cymbal
52	Tambourine	Tambourine	Techno Crash	Tambourine
53	Splash Cymbal	Splash Cymbal	Electro Ride Cymbal	Splash Cymbal
54	Cowbell	Cowbell	Tambourine	Cowbell
55	Crash	Crash	Splash Cymbal	Crash
56	VibraSlap	VibraSlap	Cowbell	VibraSlap
57	Ride Bow	Ride Bow	Crash	Ride Bow
58	Bongo Small	Bongo Small	VibraSlap	Bongo Small
59	Bongo Large	Bongo Large	Ride Bow	Bongo Large
60	Conga Mute	Conga Mute	Bongo Small	Conga Mute
61	Conga	Conga	Bongo Large	Conga
62	Tumba	Tumba	Conga Mute	Tumba
63	Timbale Hi	Timbale Hi	Conga	Timbale Hi
64	Timbale Low	Timbale Low	Tumba	Timbale Low
65	Small Agogo	Small Agogo	Timbale Hi	Small Agogo
66	Large Agogo	Large Agogo	Timbale Low	Large Agogo
67	Cabasa	Cabasa	Small Agogo	Cabasa
68	Maracas	Maracas	Large Agogo	Maracas

MIDI Note	Hip Hop	Jazz	Brush	Latin
	PC 32	PC 40	PC 48	PC 56
69	Short Whistle	Short Whistle	Cabasa	Short Whistle
70	Long Whistle	Long Whistle	Long Whistle	Long Whistle
71	Guiro Short	Guiro Short	Guiro Short	Guiro Short
72	Guiro Long	Guiro Long	Guiro Long	Guiro Long
73	Clave	Clave	Clave	Clave
74	High Woodblock	High Woodblock	High Woodblock	High Woodblock
75	Low Woodblock	Low Woodblock	Low Woodblock	Low Woodblock
76	Low Quica	Low Quica	Low Quica	Low Quica
77	Hi Quica	Hi Quica	Hi Quica	Hi Quica
78	Triangle Mute	Triangle Mute	Triangle Mute	Triangle Mute
79	Triangle-Open	Triangle-Open	Triangle-Open	Triangle-Open
80	Cabasa	Cabasa	Cabasa	Cabasa
81	Shaker	Shaker	Shaker	Shaker
82	Bell Tree	Bell Tree	Bell Tree	Bell Tree
83	Castanets	Castanets	Castanets	Castanets
84	Mute Surdo	Mute Surdo	Mute Surdo	Mute Surdo
85	Open Surdo	Open Surdo	Open Surdo	Open Surdo

MIDI Note	Orchestra	Techno	Classic Rock	LA Funk
	PC 64	PC72	PC80	PC88
25	Click- SquareWave	Click- SquareWave	Click- SquareWave	Click- SquareWave
26	BrushTap	BrushTap	BrushTap	BrushTap
27	Scratch Push	Scratch Push	Scratch Push	Scratch Push
28	Scratch Pull	Scratch Pull	Scratch Pull	Scratch Pull
29	Stick	Stick	Stick	Stick
30	Snare	Snare	Snare	Snare
31	Bass Drum	Bass Drum	Bass Drum	Bass Drum
32	Bass Drum	Bass Drum	Bass Drum	Bass Drum
33	Orchestral Bass Drum	Techno Bass drum	Big Kick	Fat Kick
34	Orchestral Bass Drum	Hip Hop Bass drum	Big Kick	Fat Kick
35	Shallow Wood Snare Cross Stick	Techno Snare	Big Snare Side Stick	Fat Snare Side Stick
36	Shallow Wood Snare	Simmons Snare	Big Snare	Fat Snare
37	Shallow Wood Snare	Techno Snare 2	Big Snare	Fat Snare
38	Shallow Wood Snare Rim Shot	Low Simmons Tom	Big Snare Rimshot	Fat Snare Rimshot

SYMPHONY GRAND II DIGITAL PIANO

MIDI Note	Orchestra	Techno	Classic Rock	LA Funk
	PC 64	PC72	PC80	PC88
39	Timpani	Techno Hi Hat closed	Big Low Tom	Fat Low Tom
40	Hi Hat Closed	Low Techno Tom	Hi Hat Closed	Hi Hat Closed
41	Timpani	Ecymbal Foot	Big Low Tom	Fat Low Tom
42	Hi Hat Foot	Midi Techno Tom	Hi Hat Foot	Hi Hat Foot
43	Vintage Mid Tom	Techno Hi Hat Open	Big Medium Tom	Fat Medium Tom
44	Hi Hat Open	Low Simmons Tom	Hi Hat Open	Hi Hat Open
45	Vintage Mid Tom	High Techno Tom	Big Medium Tom	Fat Medium Tom
46	Vintage High Tom	Techno Crash Cymbal	Big High Tom	Fat High Tom
47	Crash Cymbal	High Simmons Tom	Big High Tom	Fat High Tom
48	Vintage High Tom	Simmons Ride	Crash Cymbal	Crash Cymbal
49	Techno ride	Techno Crash Cymbal	Ride Cymbal	Ride Cymbal
50	Techno Crash	Techno Crash	China Cymbal	China Cymbal
51	Electro Ride Cymbal	Electro Ride Cymbal	Ride Bell Cymbal	Ride Bell Cymbal
52	Tambourine	Tambourine	Tambourine	Tambourine
53	Splash Cymbal	Splash Cymbal	Splash Cymbal	Splash Cymbal
54	Cowbell	Cowbell	Cowbell	Cowbell
55	Crash	Crash	Crash	Crash
56	VibraSlap	VibraSlap	VibraSlap	VibraSlap
57	Ride Bow	Ride Bow	Ride Bow	Ride Bow
58	Bongo Small	Bongo Small	Bongo Small	Bongo Small
59	Bongo Large	Bongo Large	Bongo Large	Bongo Large
60	Conga Mute	Conga Mute	Conga Mute	Conga Mute
61	Conga	Conga	Conga	Conga
62	Tumba	Tumba	Tumba	Tumba
63	Timbale Hi	Timbale Hi	Timbale Hi	Timbale Hi
64	Timbale Low	Timbale Low	Timbale Low	Timbale Low
65	Small Agogo	Small Agogo	Small Agogo	Small Agogo
66	Large Agogo	Large Agogo	Large Agogo	Large Agogo
67	Cabasa	Cabasa	Cabasa	Cabasa
68	Maracas	Maracas	Maracas	Maracas
69	Short Whistle	Short Whistle	Short Whistle	Short Whistle
70	Long Whistle	Long Whistle	Long Whistle	Long Whistle
71	Guiro Short	Guiro Short	Guiro Short	Guiro Short
72	Guiro Long	Guiro Long	Guiro Long	Guiro Long
73	Clave	Clave	Clave	Clave
74	High Woodblock	High Woodblock	High Woodblock	High Woodblock
75	Low Woodblock	Low Woodblock	Low Woodblock	Low Woodblock
76	Low Quica	Low Quica	Low Quica	Low Quica

MIDI Note	Orchestra	Techno	Classic Rock	LA Funk
	PC 64	PC72	PC80	PC88
77	Hi Quica	Hi Quica	Hi Quica	Hi Quica
78	Triangle Mute	Triangle Mute	Triangle Mute	Triangle Mute
79	Triangle-Open	Triangle-Open	Triangle-Open	Triangle-Open
80	Cabasa	Cabasa	Cabasa	Cabasa
81	Shaker	Shaker	Shaker	Shaker
82	Bell Tree	Bell Tree	Bell Tree	Bell Tree
83	Castanets	Castanets	Castanets	Castanets
84	Mute Surdo	Mute Surdo	Mute Surdo	Mute Surdo
85	Open Surdo	Open Surdo	Open Surdo	Open Surdo

MIDI Note	Metal	Heavy Metal	Vintage	Sound Effects
	PC96	PC104	PC112	PC120
25	Click- SquareWave	Click- SquareWave	Click- SquareWave	Click- SquareWave
26	BrushTap	BrushTap	BrushTap	BrushTap
27	Scratch Push	Scratch Push	Scratch Push	Scratch Push
28	Scratch Pull	Scratch Pull	Scratch Pull	Scratch Pull
29	Stick	Stick	Stick	Stick
30	Snare	Snare	Snare	Snare
31	Bass Drum	Bass Drum	Bass Drum	Bass Drum
32	Bass Drum	Bass Drum	Bass Drum	Bass Drum
33	Metal Kick	Heavy Metal Kick	Vintage Kick	Seashore
34	Metal Kick	Heavy Metal Kick	Vintage Kick	Bird
35	Metal Snare Side Stick	Heavy Metal Snare Side Stick	Vintage Snare Side Stick	Telephone
36	Metal Snare	Heavy Metal Snare	Vintage Snare	Helicopter
37	Metal Snare	Heavy Metal Snare	Vintage Snare	Applause
38	Metal Snare Rimshot	Heavy Metal Snare Rimshot	Vintage Snare Rimshot	GunShot
39	Metal Low Tom	Heavy Metal Low Tom	Vintage Low Tom	Low Studio Tom
40	Hi Hat Closed	Hi Hat Closed	Hi Hat Closed	Hi Hat Closed
41	Metal Low Tom	Heavy Metal Low Tom	Vintage Low Tom	Mid Studio Tom
42	Hi Hat Foot	Hi Hat Foot	Hi Hat Foot	Hi Hat Foot
43	Metal Med Tom	Heavy Metal Med Tom	Vintage Med Tom	Mid Studio tom
44	Hi Hat Open	Hi Hat Open	Hi Hat Open	Hi Hat Open
45	Metal Med Tom	Heavy Metal Med Tom	Vintage Med Tom	High Studio Tom
46	Metal High Tom	Heavy Metal High Tom	Vintage High Tom	High Studio Tom
47	Metal High Tom	Heavy Metal High Tom	Vintage High Tom	Crash Cymbal
48	Crash Cymbal	Crash Cymbal	Crash Cymbal	High Studio Tom
49	Ride Cymbal	Ride Cymbal	Ride Cymbal	Ride Bow Cymbal

SYMPHONY GRAND II DIGITAL PIANO

MIDI Note	Metal	Heavy Metal	Vintage	Sound Effects
	PC96	PC104	PC112	PC120
50	China Cymbal	China Cymbal	China Cymbal	China Cymbal
51	Ride Bell Cymbal	Ride Bell Cymbal	Ride Bell Cymbal	Ride Bell Cymbal
52	Tambourine	Tambourine	Tambourine	Tambourine
53	Splash Cymbal	Splash Cymbal	Splash Cymbal	Splash Cymbal
54	Cowbell	Cowbell	Cowbell	Cowbell
55	Crash	Crash	Crash	Crash
56	VibraSlap	VibraSlap	VibraSlap	VibraSlap
57	Ride Bow	Ride Bow	Ride Bow	Ride Bow
58	Bongo Small	Bongo Small	Bongo Small	Bongo Small
59	Bongo Large	Bongo Large	Bongo Large	Bongo Large
60	Conga Mute	Conga Mute	Conga Mute	Conga Mute
61	Conga	Conga	Conga	Conga
62	Tumba	Tumba	Tumba	Tumba
63	Timbale Hi	Timbale Hi	Timbale Hi	Timbale Hi
64	Timbale Low	Timbale Low	Timbale Low	Timbale Low
65	Small Agogo	Small Agogo	Small Agogo	Small Agogo
66	Large Agogo	Large Agogo	Large Agogo	Large Agogo
67	Cabasa	Cabasa	Cabasa	Cabasa
68	Maracas	Maracas	Maracas	Maracas
69	Short Whistle	Short Whistle	Short Whistle	Short Whistle
70	Long Whistle	Long Whistle	Long Whistle	Long Whistle
71	Guiro Short	Guiro Short	Guiro Short	Guiro Short
72	Guiro Long	Guiro Long	Guiro Long	Guiro Long
73	Clave	Clave	Clave	Clave
74	High Woodblock	High Woodblock	High Woodblock	High Woodblock
75	Low Woodblock	Low Woodblock	Low Woodblock	Low Woodblock
76	Low Quica	Low Quica	Low Quica	Low Quica
77	Hi Quica	Hi Quica	Hi Quica	Hi Quica
78	Triangle Mute	Triangle Mute	Triangle Mute	Triangle Mute
79	Triangle-Open	Triangle-Open	Triangle-Open	Triangle-Open
80	Cabasa	Cabasa	Cabasa	Cabasa
81	Shaker	Shaker	Shaker	Shaker
82	Bell Tree	Bell Tree	Bell Tree	Bell Tree
83	Castanets	Castanets	Castanets	Castanets
84	Mute Surdo	Mute Surdo	Mute Surdo	Mute Surdo
85	Open Surdo	Open Surdo	Open Surdo	Open Surdo



PLAYING CHORDS IN STYLE MODE

There are two modes for playing harmonies in the Style arranger when the Chord function is on.

Single Mode

SINGLE Mode fingering makes it simple to produce beautifully orchestrated accompaniment by using major, seventh, minor and minor-seventh chords by pressing a minimum number of keys in the Auto Accompaniment section of the keyboard. The accompaniment produced is perfectly matched to the currently selected accompaniment style.

Major Chords

If you press a "C" key in the left-hand section of the keyboard, for example, a C-major accompaniment will be played. Press another key in the left hand

section of the keyboard to select a new chord. The key you press will always determine the "root" of the chord played (i.e. "C" for a C chord).

Minor Chords

Simultaneously press the root key and a black key to its left.

7th Chords

Simultaneously press the root key and a white key to its left

Minor 7th Chord

Simultaneously press the root key and both a white and black key to its left.

Major Chords



Minor Chords

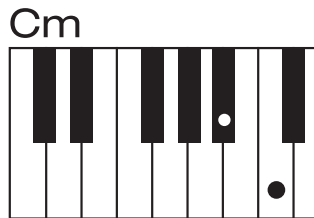

7th Chords





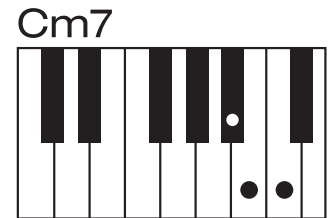

Minor 7th Chord

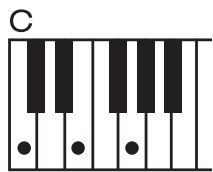
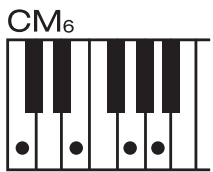
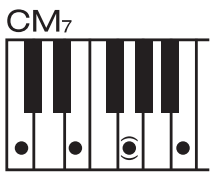
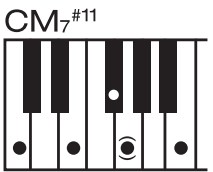
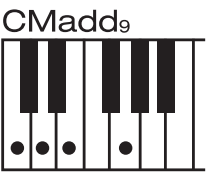
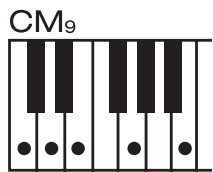
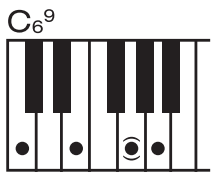
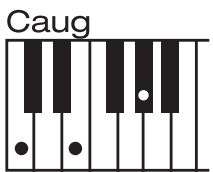
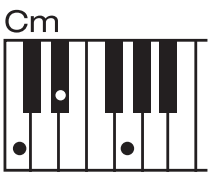
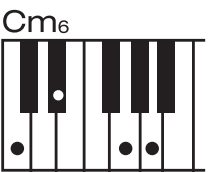
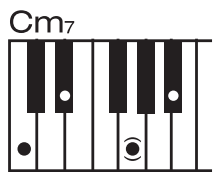
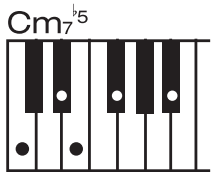
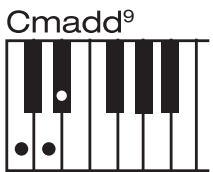
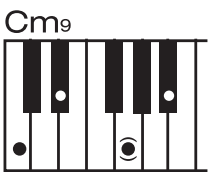
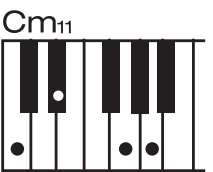
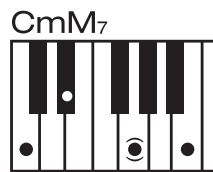
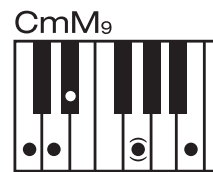

SYMPHONY GRAND II DIGITAL PIANO

Fingered Mode

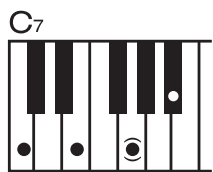
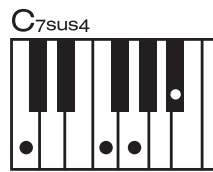
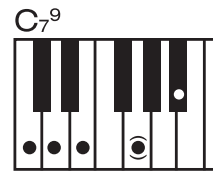
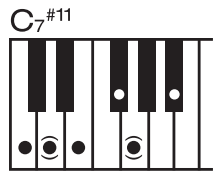
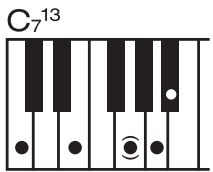
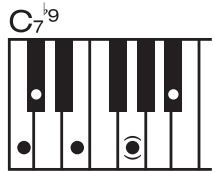
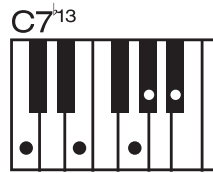
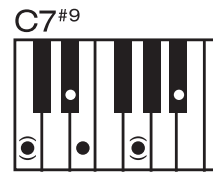
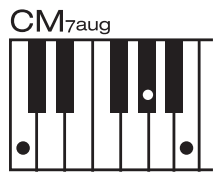
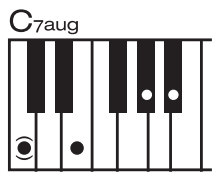
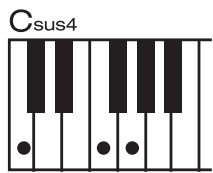
Fingered Mode is ideal if you already know how to play chords on a keyboard, since it allows you to supply your own chords for the Auto Accompaniment feature. The instrument will recognize the following chord types:

The chord fingerings listed are all in root position, but other inversions can be use with the following exceptions: m7,m7b5, 6, m6, sus4, aug, dim7, 6(9), m7(11), 1+2+5.



FINGERED MODE CHART

Name	Fingering	Chord(C)	Display
[M]	1-3-5	C	C
[6]	1-(3)-5-6	C6	C6
[M7]	1-3-(5)-7or1-(3)-5-7	CM7	CM7
[M7#11]	1-(2)-3-'4-(S)-7 or 1-2-3-14-(5)-7	CM7'11	CM7("11)
[Madd9]	1-2-3-5	CMBdd9	C(9)
[M9]	1-2-3-{5}-7	CM9	CM7(9)
[6 9]	1-2-3-{5}-6	C69	C6(9)
[aug]	1-3-'5	Clllll!	Gwg
[m]	1-'3-5	Cm	Cm
[m6]	1-'3-5-6	Cm6	Cm6
[m7]	1-'3-(5)- '7	Cm7	Cm7
[m7b5]	1-'3- •s- '7	Cm7'5	Cm7'5
[lDBdd9]	1-2-'3-5	CIDBdd9	Cm(9)
[m9]	1-2-'3-(5)-'7	Cm9	Cm7(9)
[mil]	1-(2)- "3-4-5-('7)	Cmll	Cm7(11)
[mM9]	1-2-"3-(5)-7	CmM9	CmM7(9)
[dim]	t- '3- •s	Cdim	Cdim
[dim7]	1-'3-'5-6	Cdim7	Cdim7
[7]	1-3-(5)- '7 or 1-{3}-5-'7	C7	C7
[7SUB4]	1-4-(5)- '7	C7sus4	C711184
[7 9]	1-2-3-(5)-'7	C79	C7(9)
[7#11]	1-(2)-3-'4-(5)-'7 or 1-2- 3-'4-(5)- '7	C7'11	C7("11)
[713]	1-3-(5)-6-'7	C713	C7(13)
[7b9]	1-'2-3-(S)- '7	C7'9	C7('9)
[7b13]	1-3-5- '6-'7	C7 '13	C7('13)
[7#9]	1-'2-3-(5)- '7	C7'9	C7("9)
[M7aug]	1-{3}-'5-7	CM7aug	CM7aug
[7aug]	1-3-'5- '7	C7aug	C7aug
[11184]	1-4-S	Csus4	Csus4
[1+2+5]	1-2-S	C1+2+5	C

MIDI IMPLEMENTATION CHART

Function	Transmitted	Recognized	Remarks
Basic Default Channel Changed	1-16 CH X	1-16 CH 1-16 CH	
Mode Default Messages Altered	Mode 3 X *****	Mode 3 X X	
Note Number: True Voice	0~127 *****	0~127 0~127	
Velocity Note ON Note OFF	O 9nH,v=1~127 O 8nH,v=0	O 9nH,v=1~127 O 9nH,v=0 or 8nh	
After Key's	X	X	
Pitch Bender	X	O	
Control Change 0, 32 1 6 7 10 11 64 66 67 80, 81 84 91, 93 98, 99 100, 101 121	X X X O X X O X O X X X X X X O	O O O O O O O O O O O O O (*2) O (*1) O	Function Modulation Data Entry Volume Pan Expression Sustain Sostenuto Soft Pedal DSP Type Portamento DSP Depth NRPN LSB, MSB RPN LSB, MSB Reset All Controllers
Program Change: True	O 0-127 0-127	O 0-127 0-127	
System Exclusive	X	O	
System :Song Position :Song Select Common :Tune	X X O	X X X	
Aux :Local ON/OFF :All Notes OFF Messages :Active Sense :Reset	O O X O	O O X O	

Mode1:OMNI ON, POLY Mode2:OMNI ON,MONO O: Yes
Mode3:OMNI OFF, POLY Mode4:OMNI OFF,MONO X: NO

*1: Registered parameter number:
#0: Pitch sensitivity
#1: Fine tuning in cents
#2: Coarse tuning in half-tones

*2: NRPN 1220h select IFX type
0: off
1: slow rotary
2: fast rotary
3: auto_pan
4: auto_tremelo

NRPN 1230h
Enable IFX for current track
NRPN 1237h
set global reverb send level if IFX have been enable on this track
NRPN 1238h
set global chorus send level if IFX have been enable on this track



SONG TUTOR LIST

Difficulty	Order	Display Name	File Name
Hard	1	Rachmnv	Rachmoninov - Prelude in C# Minor
	2	Chopin 1	Chopin - Fantasy Impromptu
	3	Bach 1	Bach - C Major Prelude
	4	Debussy1	Debussy - Clair de Lune
	5	Bach 2	Bach - Italian Concerto (Harpsic)
	6	Liszt	Liszt - Liebestraume
	7	Bach 3	Bach - C# Major Prelude
	8	Beethvn1	Beethoven - Moonlight
	9	Debussy2	Debussy - Dr. Gradus
	10	Bach 4	Bach - Mighty Fortress (Organ)
	11	Bach 8	Bach - Jesu 1 BWV776
Medium	12	Beethvn2	Beethoven - Rondo a capriccio OP129 G-major
	13	Bach 5	Bach - Bourree
	14	Bach 6	Bach-Invention - 08 F major
	15	Bach 7	Bach - Minuet 1
Easy	16	Chopin 2	Chopin - Prelude E Minor 1
	17	Chopin 3	Chopin - Minuet Waltz
	18	Mozart	Mozart - Minuet in F
	19	Grnslves	Greensleeves
	20	Satie	Gymnopedie
	21	AvaMaria	Ava Maria.mid
Rock Blues	22	Pachelbl	Johann Pachelbel - Canon
	23	Blues 1	Blues 1
	24	Blues 2	Boogie1
	25	Blues 3	Boogie2
	26	Rock 1	Rock3
	27	Rock 2	Rock5
	28	Rock 3	Rock1
	29	Rock 4	Rock4
	30	Rock 5	Rock2
	31	Rock 6	Rock6
	32	Blues 4	Blues 4
Etudes	33	Etude 1	Etude 1
	34	Etude 2	Etude 2
	35	Etude 3	Etude 3
	36	Etude 4	Etude 4
	37	Etude 5	Etude 5
	38	Etude 6	Etude 6
	39	Etude 7	Etude 7
	40	Etude 8	Etude 8
	41	Etude 9	Etude 9
	42	Etude 10	Etude 10
	43	Etude 11	Etude 11
	44	Etude 12	Etude 12
	45	Etude 13	Etude 13
	46	Etude 14	Etude 14
	47	Etude 15	Etude 15
	48	Etude 16	Etude 16
	49	Etude 17	Etude 17
	50	Etude 18	Etude 18

